

**Fiberdeck**<sup>®</sup>



**CATALOGUE 2023**



Reliable products, **designed to last many years and preserve the environment.** As our natural resources are limited, we must protect and recycle for future generations. **Our products are made from 95% recycled plastic waste.**

Leader in our market, we are constantly looking for new solutions **to improve the durability of our products and simplify their installation.** Fiberdeck® is a **young and dynamic team that shares the same values** and promotes collaborative work. Respect for all our employees is the key to our success.



# TABLE OF CONTENTS



08



18



62

## DECKING

<b>BROOKLYN</b>	08
<b>HERITAGE</b>	10
<b>MANHATTAN</b>	12
<b>VINTAGE</b>	14
<b>COBRA CLIPS &amp; SCREWS</b>	16

## FENCING

<b>MODERN COMPOSITE WOOD</b>	20
<b>PREMIUM COMPOSITE WOOD</b>	22
<b>CRIOS DECOR</b>	24
<b>HERA DECOR</b>	26
<b>PAXOS DECOR</b>	28
<b>LAMIA DECOR</b>	30
<b>CLARITY DECOR</b>	32
<b>ALUMINIUM COMBO</b>	34
<b>ALUMINIUM OPALE</b>	36
<b>ALUMINIUM OPEN 45</b>	38
<b>ALUMINIUM OPEN 100</b>	40
<b>ALUMINIUM RHOMBUS</b>	42
<b>COMPONENTS</b>	44

## SIGHTSCREEN FENCING

<b>AKIDO SIGHTSCREEN FENCING KIT</b>	54
--------------------------------------	----

## CLADDING

<b>WEO® CLASSIC</b>	64
<b>WEO® 35</b>	66
<b>WEO® 60</b>	68
<b>WEO® BRISE-SOLEIL</b>	70
<b>TECHNICAL INFORMATION</b>	72



## ADVANTAGES COMPARED TO OTHER COMPOSITE WOODS

- ✓ Made from 95% recycled material
- ✓ Guaranteed for 20 years without fading
- ✓ Unique natural decors and textures
- ✓ PVC and formaldehyde free
- ✓ Stain resistant
- ✓ Very high dimensional stability
- ✓ Easy to install and remove

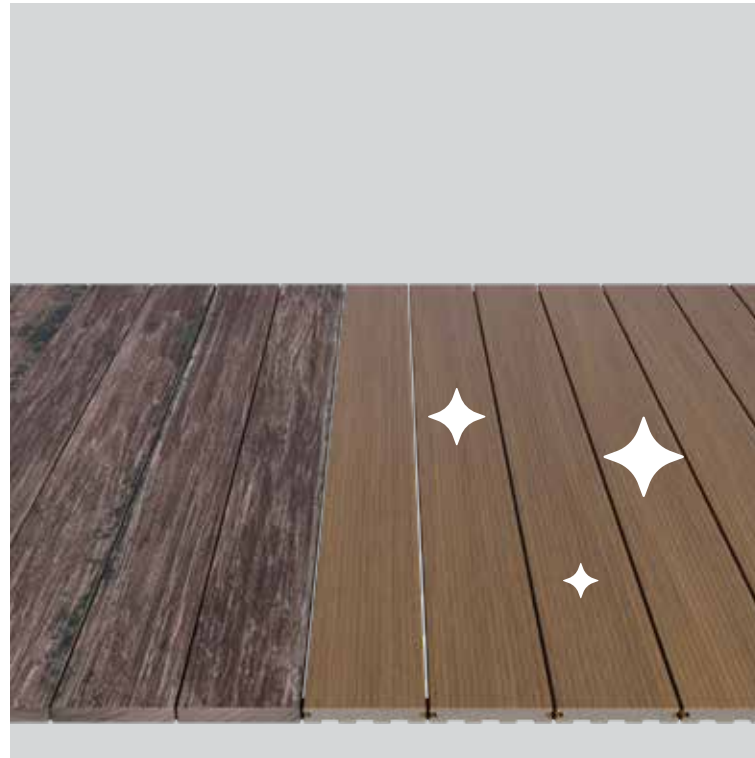

## A HIGHLY DURABLE COMPOSITE WOOD

Fiberdeck® is committed to the durability of its products and guarantees its decking, cladding and fencing range for 10 to 20 years (commercial, professional and public/residential use) against splintering and structural damage due to fungus, wood-eating insects or termites, as well as the colour and stain resistance of the products over the same period.

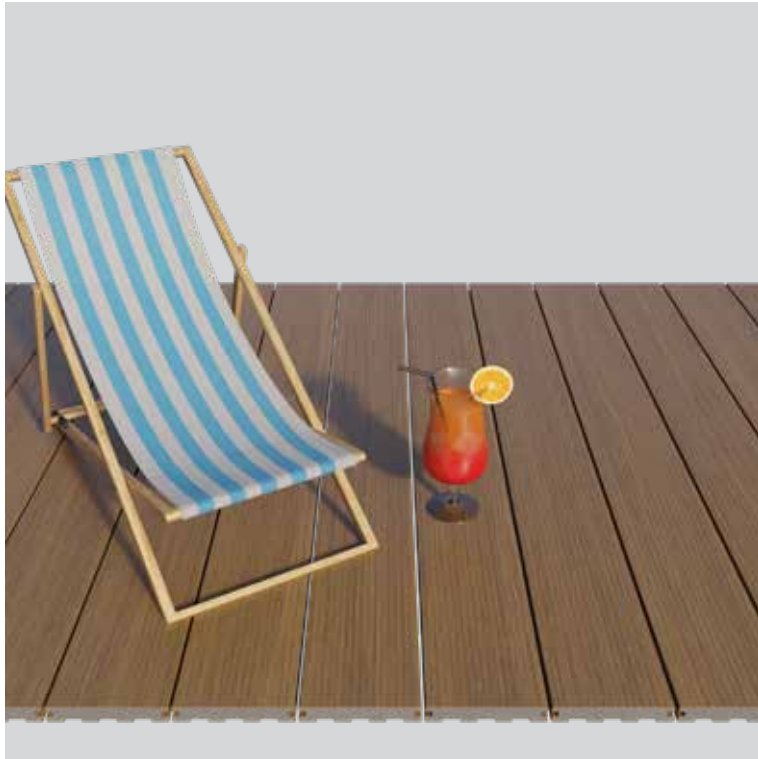

## ULTRA LOW MAINTENANCE

Simple cleaning with high-pressure water (120 bar) is sufficient to clean your Fiberdeck® deck. Thanks to the polyethylene protective layer, Fiberdeck® decking will not turn grey or stain. The natural colour, look and feel of the wood will persist in the most extreme climates and temperatures. The aesthetics of the pattern are preserved over several decades while generating significant maintenance savings.



## AND MADE WITH 95% RECYCLED WASTE

Fiberdeck® decking is made from 95% recycled wood waste and polymers. Wood is the main component with nearly 60% of the volume, and comes from FSC-certified sawdust from the manufacturing industry. The polymers come from recycled plastic bottles. We recycle 40 million plastic bottles in our products every year. Thousands of tons of plastic waste are thus recycled to manufacture a product with superior performance to natural wood.

# DECKING COMPOSITE WOOD





# COMPOSITE WOOD WITH OUTSTANDING PERFORMANCE

## CO-EXTRUSION, A CUTTING-EDGE TECHNOLOGY

Co-extrusion is a new technology that is disrupting the composite wood market. The recurring problems of staining and fading of first-generation mono-extruded boards have led us to use co-extrusion technology. It consists of applying a very thin, molten polyethylene film on the composite wood. This waterproof film protects the wood from any moisture issues and stabilises the material. Expansion is also reduced to a minimum. Our 100% co-extruded Fiberdeck® decking profiles offer much better quality than any other product on the market.

## 20-YEAR GUARANTEE WITHOUT FADING

With a wealth of experience in this new technology and several million square metres marketed to date in a wide range of climates, we can guarantee our products for up to 20 years without any visible fading.

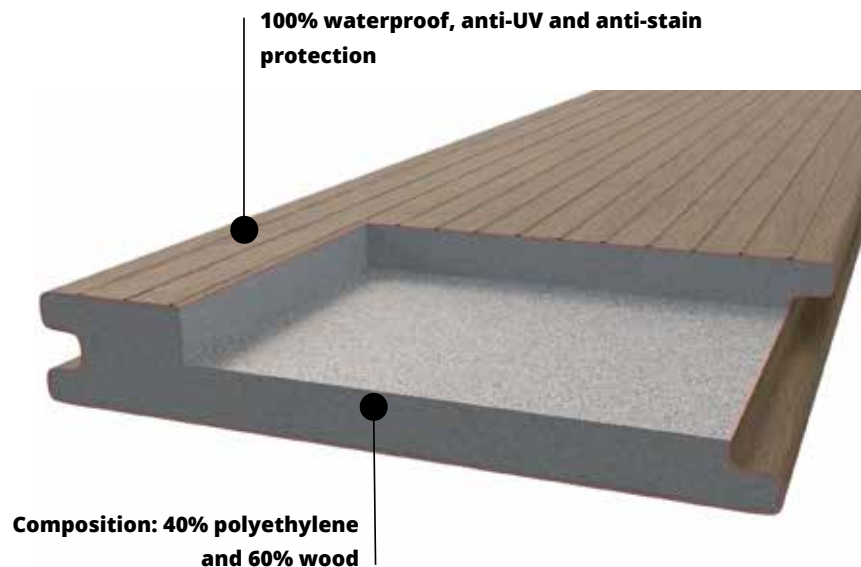



## A REVERSIBLE PROFILE WITH A CHOICE OF TWO DECORS

BROOKLYN boards offer a choice of smooth and textured wood grain in 4 multi-chromatic colours. The co-extrusion protective layer on both sides guarantees very low expansion of the boards and durable colour over time. The finishing boards associated with this range can be adapted to all configurations. Removable boards.



## DECKING BOARD BROOKLYN

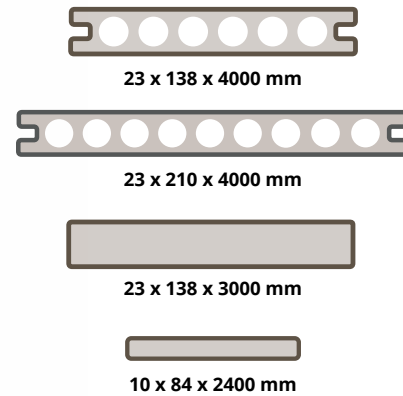

	Light Grey	Dark Grey	Teak	Ipe
	FD1239	FD1238	FD1241	FD1240
	FD1243	FD1242	FD1245	FD1244
	FD1247	FD1246	FD1249	FD1248
	FD0707	FD0706	FD0895	FD0708



Non-slip R11



Anti-stain



15-years guarantee



UV resistant



REVERSIBLE BOARD



**Cobra® Hybrid 8-18 clips**  
(90 clips + screws)  
1 bag for 4.5 m<sup>2</sup>  
FD0993



**Cobra® Start/End**  
(30 clips + 30 screws)  
FD0336



LIGHT GREY



DARK GREY



TEAK

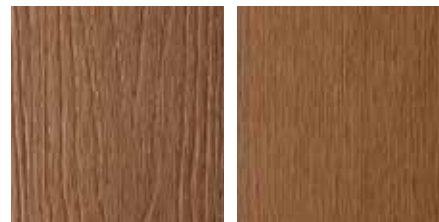

IPE

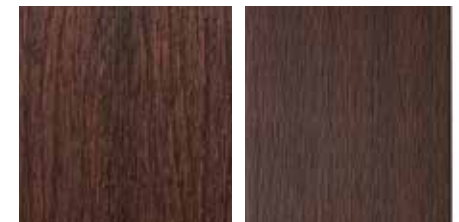



## A BOARD WITH SCULPTED CHARACTER

The new HERITAGE board has a unique design that perfectly imitates exotic wood. The pores of the wood are reproduced down to the smallest detail. The surface of the board has irregularities that catch the light and give rhythm. This is an “adze” look, which corresponds to the traditional carpenter’s tool for smoothing out a piece of wood. This board has a new co-extrusion coating that is highly resistant to abrasion. The protective layer is hard and limits scratches. This layer is present on all 4 sides of the board.



# DECKING BOARD HERITAGE



23 x 138 x 4000 mm



23 x 138 x 3000 mm

Ocean Grey	Indian Summer	Havana Brown
FD1225	FD1226	FD1227
FD1250	FD1253	FD1252



**Cobra® Hybrid 8-18 clips**  
(90 clips + screws)  
1 bag for 4.5 m<sup>2</sup>  
FD0993



**Cobra® Start/End**  
(30 clips + 30 screws)  
FD0336



Anti-stain



20-years guarantee



UV resistant

OCEAN GREY



INDIAN SUMMER



HAVANA BROWN

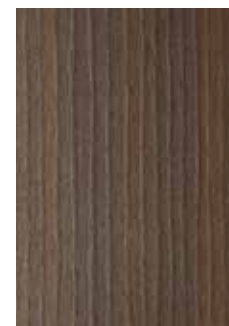



## SMOOTH OR REEDED, A STRIKING WOOD DECOR !

MANHATTAN boards are available with a choice of smooth or reeded faces in 4 multi-chromatic colours. The colours are guaranteed for 20 years and the decking requires very low maintenance. The grooves catch the light to give relief to the decking. The finishing boards, combined with this range, allow all types of finishes to be created for swimming pool coping, stairs and skirting boards.



## DECKING BOARD MANHATTAN



Anti-stain



20-years guarantee



UV resistant



Non-slip R11



23 x 145 x 3600 mm



23 x 138 x 3000 mm



10 x 84 x 2400 mm

	Dark grey	Light grey	Ipe	Teak
	FD1025	FD1026	FD1027	FD1028
	FD1246	FD1247	FD1248	FD1249
	FD0706	FD0707	FD0708	FD0895

 REVERSIBLE BOARD



**Cobra® Hybrid 8-18 clips**  
(90 clips + screws)  
1 bag for 4.5 m<sup>2</sup>  
FD0993



**Cobra® Start/End**  
(30 clips + 30 screws)  
FD0336



DARK GREY

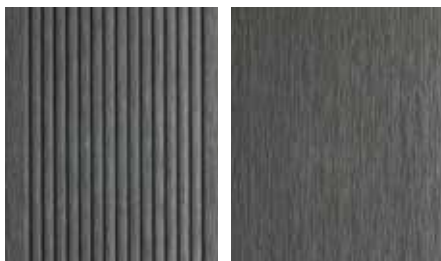

LIGHT GREY

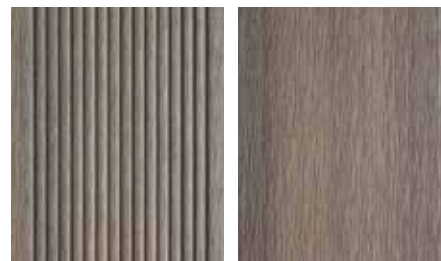

IPE

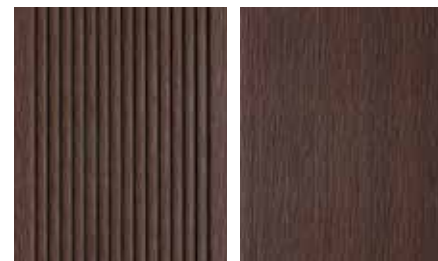

TEAK





## A STUNNING AND UNIQUE OLD WOOD LOOK

VINTAGE boards brilliantly reproduce the look of boards that have aged and developed a patina over time. The embossed material of the wood fibres gives a natural wood feel. Available in 2 widths and 3 colours, the Wengé, Lunar Grey and Graphite solid boards come in 2 different decors. The co-extrusion layer guarantees their colour for 20 years without fading. VINTAGE boards are designed to last with very low maintenance.

# DECKING BOARD VINTAGE

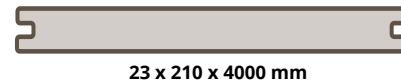
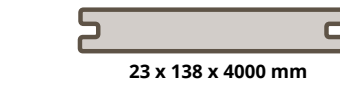

**Graphite**

**Lunar Grey**

**Wengé**

FD1125

FD1126

FD1127

FD1128

FD1129

FD1130

FD1131

FD1132

FD1133



**Cobra® Hybrid 8-18 clips**  
(90 clips + screws)  
1 bag for 4.5 m<sup>2</sup>  
FD0993



**Cobra® Start/End**  
(30 clips + 30 screws)  
FD0336



Anti-stain



20-years guarantee



UV resistant

GRAPHITE

LUNAR GREY

WENGE



 **REVERSIBLE BOARD**

## COMPOSITE DECKING FASTENER

# CLIPS & SCREWS



**COBRA HYBRID 8-18 CLIPS**  
Set of 90 clips with screws  
for wood and aluminium.  
Approx. 4.5 m<sup>2</sup>  
FD0993



**COBRA START/END CLIPS**  
Clip in stainless steel AISI304  
(30 pcs) 4.5x25 mm screws in  
stainless steel AISI304 (30 pcs)  
FD0336 / FD1432



**COBRA SCREWS FOR  
COMPOSITE WOOD DECKING**  
Set of 150 screws in stainless  
steel AISI304 with end caps  
FD0770 / FD0771







# DISCOVER

all the FASTENING AND STRUCTURE SOLUTIONS for Composite Wood DECKING on the website

<https://www.cbrafastener.com>

# BOSTON COMPOSITE FENCING





THE CONCEPT **Fiberdeck**<sup>®</sup>

# BOSTON

Boston is an ecosystem of products designed to adapt to your environment, needs and desires. The posts are fixed in the ground, on a slab or low wall and the fence is easily assembled by interlocking.



COMPOSITE

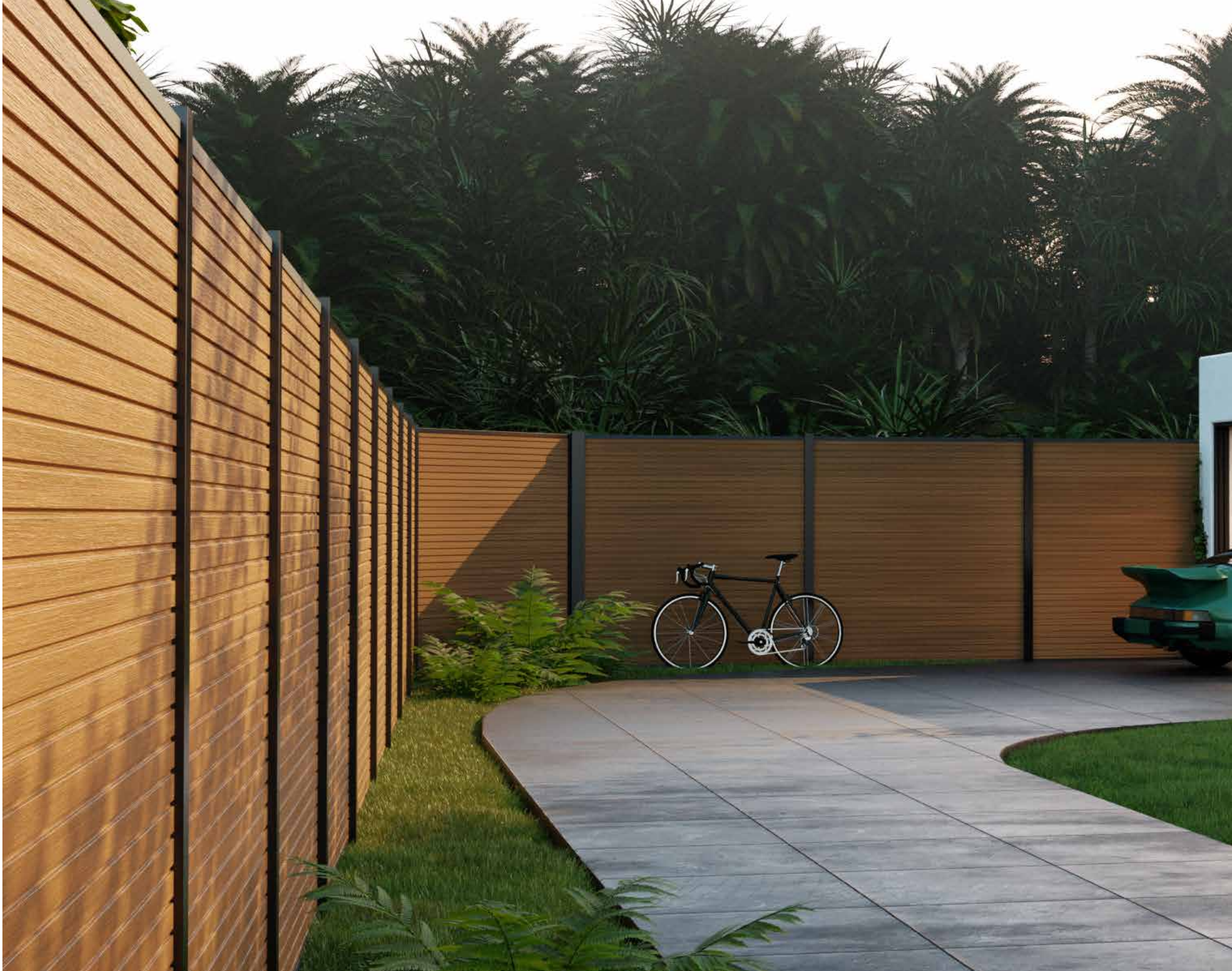

# MODERN

**Fiberdeck**<sup>®</sup>

The MODERN board's carefully calibrated grooves create an elegant faux-slat effect. These composite wood boards are guaranteed not to fade under the most extreme conditions, thanks to the co-extrusion process.

- *The board can also be stiffened with aluminium reinforcements.*
- *The corner kit is available to create a completely free contour.*

Dark Grey

**FD1118**

Teak

**FD1121**

Cedar

**FD1531**



*Modern Teak boards*



# PREMIUM



Resulting from extensive research and development, our Premium composite wood boards are protected against insects and termites. They are protected against UV rays and are therefore guaranteed for 20 years against fading and staining.

A thin polymer layer protects these boards across the entire surface to ensure a perfect seal.

• *These boards can also be stiffened with aluminium reinforcements.*



Dark Grey

**FD1232**



Teak

**FD1234**

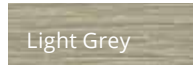

Light Grey

**FD1235**



Ipe

**FD1233**



*Premium Dark Grey boards*





COMPOSITE





# CRIOS

**Fiberdeck**<sup>®</sup>

A breath-taking view with a geometric decor, for a moment that will remain frozen for eternity. Crios is a laser-cut aluminium decor with a pattern reminiscent of a giant set of bricks that lets light and landscape through while providing adequate privacy.

- *The perimeter frame elements ensure seamless integration and a perfect finish.*
- *A wall plate support that distributes forces evenly is also available for wall mounting without grouting or cracking.*



**CRIOS VERTICAL DECOR**  
H 1820 x L 584 mm  
**FD1214**



**CRIOS HORIZONTAL DECOR**  
H 300 x L 1750 mm  
**FD1213**

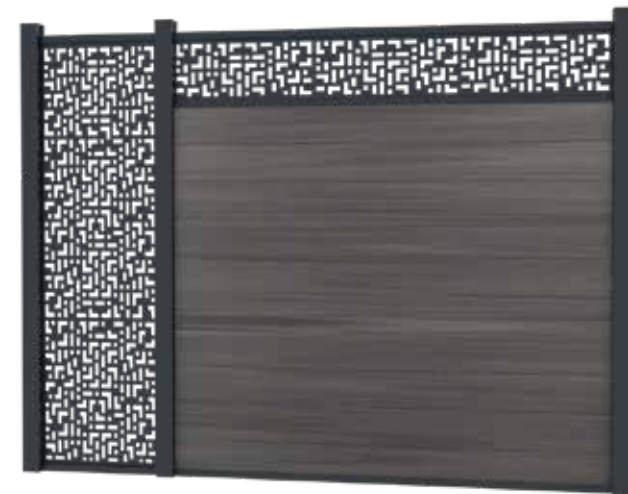

*Premium Dark Grey boards and Crios horizontal decors.  
Mounting on a wall plate support*

# HERA

**Fiberdeck**<sup>®</sup>

Featuring intertwined lines of varying thicknesses, the Hera decor is remarkably balanced and will look amazing in both urban and countryside settings.

The decors are provided with a grooved aluminium frame that fits perfectly on the aluminium or composite boards and in the rebates of the posts.

- *2 models to choose from: horizontal or vertical.*
- *The horizontal HERA decor replaces exactly 2 composite boards.*



**HERA VERTICAL DECOR**  
H 1820 x L 584 mm  
**FD1011**



**HERA HORIZONTAL DECOR**  
H 300 x L 1750 mm  
**FD1010**



*Modern Cedar boards and  
Hera horizontal/vertical decors*

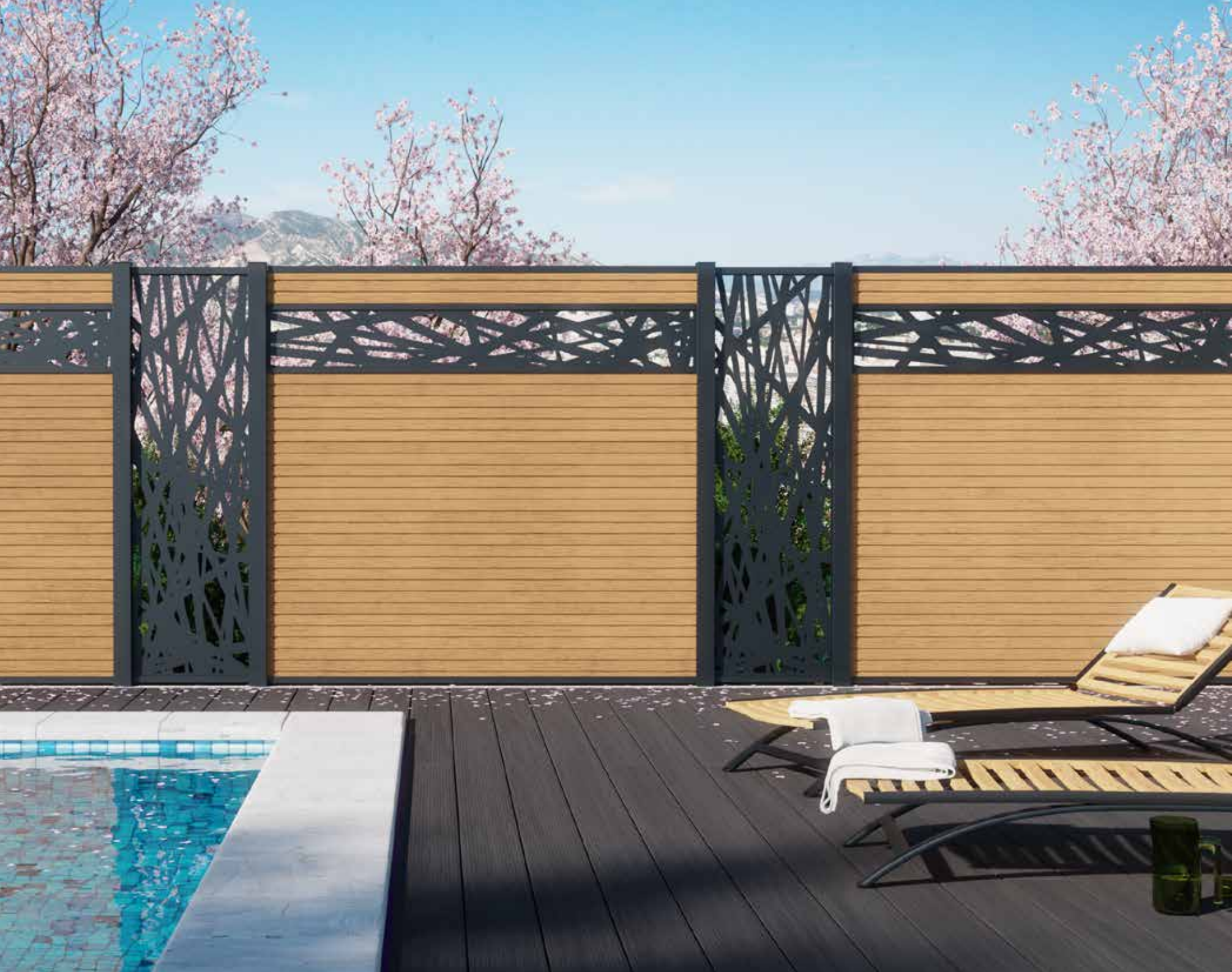



# PAXOS

**Fiberdeck**<sup>®</sup>

Orange light breaks through the Paxos decors, forming a subtle and regular shadow play.

The 3mm-thick powder-coated decors are delivered with an aluminium frame, which is assembled on the aluminium or composite boards and in the posts.

- 2 models to choose from: horizontal or vertical.
- The horizontal PAXOS decor replaces exactly 3 composite boards.



**PAXOS VERTICAL DECOR**  
H 1820 x L 875 mm  
**FD1009**



**PAXOS HORIZONTAL DECOR**  
H 450 x L 1750 mm  
**FD1008**



*Premium Teak boards and Paxos vertical/  
horizontal decors*

# LAMIA

**Fiberdeck**<sup>®</sup>

A surprising moiré effect is achieved with the Lamia decor, reminiscent of foam on the sea, even in the middle of the desert. Thanks to its powder-coated aluminium structure, the Lamia collection is extremely durable.

- 2 models to choose from: horizontal or vertical.
- The horizontal LAMIA design replaces exactly 2 composite boards.



**LAMIA VERTICAL DECOR**  
H 1820 x L 584 mm  
**FD1216**



**LAMIA HORIZONTAL DECOR**  
H 300 x L 1750 mm  
**FD1215**



*Premium Teak boards and Lamia  
vertical/horizontal decors*







# CLARITY

**Fiberdeck**<sup>®</sup>

Clarity frosted glass panels allow light to pass through while maintaining adequate privacy.

8 mm-thick frosted glass panels can be combined with composite or aluminium boards to form modern and stylish filter panels.

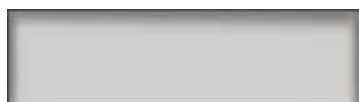

**FROSTED GLASS PANEL**  
8 X 300 X 1780 mm **FD1218**  
8 X 450 X 1780 mm **FD1219**



*Premium light grey boards  
and 300 mm-high frosted glass panel*

# COMBO

**Fiberdeck**<sup>®</sup>

The Opale interlocking aluminium board can be combined with the Premium composite wood boards to form a Combo fence panel. The boards can be arranged in any order. The resulting contrast in colour and texture is highly sought after and will enhance the enclosed area.

Aluminium  
RAL7016

**FD0868**

**IN COMBINATION WITH :**

Dark Grey

**FD1232**

Teak

**FD1234**

Light Grey

**FD1235**

Ipe

**FD1233**



*Mix of Opale aluminium boards and Premium  
Light Grey boards with Light Grey wicket gate*



ALUMINIUM

# ALUMINIUM



# OPALE

**Fiberdeck**<sup>®</sup>

This standard board is a must in our aluminium range and will delight those who are looking for a pure, uniform, sober fence that gives way to the very nature of the outdoor space. This board can be fitted with light fixtures to take advantage of the frame setting created by the fence.

It can also be combined with composite wood boards to create a warm contrast.

Aluminium  
RAL7016



*Opale aluminium boards  
and Open 45 boards with 15 mm wedges*

# OPEN 45

**Fiberdeck**<sup>®</sup>

The Open 45 mm aluminium board is distinctive and elegant. Ideal for low walls, it allows air to pass through, thus increasing wind resistance. Furthermore, it makes it possible to comply with town planning regulations while preserving privacy and aesthetic purity.

The Open 45 mm board can be combined with 15mm or 30mm wedges to achieve the desired spacing.

Aluminium  
RAL7016



Aluminium boards  
21 x 45 x 1780 mm + 30 mm wedges  
**FD1198 / FD1201**



Aluminium boards  
21 x 45 x 1780 mm + 15 mm wedges  
**FD1198 / FD1200**

*Open 45 boards with 15 mm wedges*



ALUMINIUM

# ALUMINIUM





# OPEN 100

**Fiberdeck**<sup>®</sup>

The Open 100 mm aluminium board offers a subtle balance between sight screening and letting the light in. Its strong visual design creates a protective and robust appearance. It is possible to grow plants on the fence to give the Open 100 mm fence an organic feel that will contrast with its straight features.

The Open 100 mm board is manufactured according to the Qualicoat and Qualimarine processes

Aluminium  
RAL7016



Aluminium boards  
21 x 100 x 1780 mm + 30 mm wedges  
**FD1197 / FD1201**



Aluminium boards  
21 x 100 x 1780 mm + 15 mm wedges  
**FD1197 / FD1200**

*Open 100 boards with 30 mm wedges  
Mounting on a low wall*

# RHOMBUS

**Fiberdeck**<sup>®</sup>

Latest addition to the Fiberdeck aluminium range, the Rhombus board stands out for its parallelepiped shape. This creates a louver effect to look outside without being seen.

This board receives the usual Fiberdeck quality treatment, with a Qualicoat and Qualimarine certified powder coating in anthracite grey 7016

Aluminium  
RAL7016



Aluminium Rhombus boards  
21 x 75 x 1780 mm + 10 mm wedges  
**FD1564 / FD1643**

*Aluminium Rhombus boards  
and 10 mm wedges*



ALUMINIUM

# FENCING COMPONENTS



INNOVATION

# CORNER KIT FOR ANGLE POST

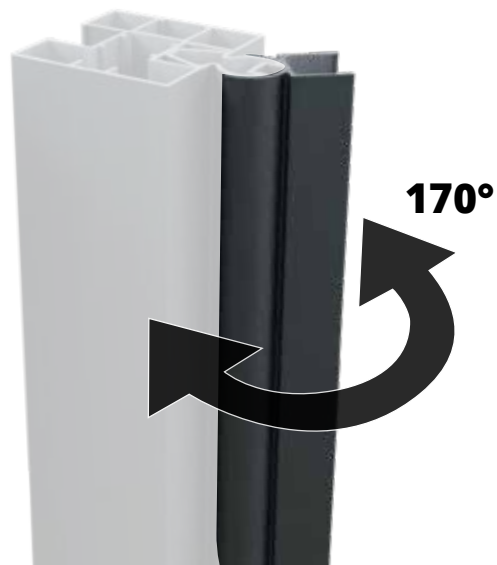
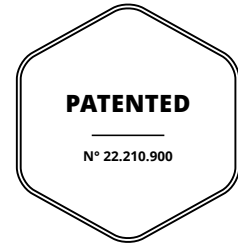

The BOSTON fence corner kit allows you to set any angle in the fence line. The pivot pin is clipped into the rebate of the post and the pivot slides over it.

The swivel part holds the boards like a conventional post. It is possible to create angles from 10° to 170°.

The whole is held in position with the associated screws and closed with a specially designed cap.

**FD1338**



[fr.myfenceplanner.com](http://fr.myfenceplanner.com)



# ALUMINIUM

The aluminium boards as well as the posts and decors are powder coated (RAL7016) and Qualicoat and Qualmarine certified. Therefore they have excellent durability and good resistance to the elements. These boards can be combined harmoniously with the composite boards and decors to create structured patterns.

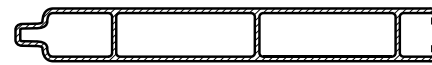

21 x 150 x 1780 mm  
Interlocking board **FD0868**



21 x 45 x 1780 mm  
Open 45 **FD1198**

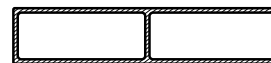

21 x 100 x 1780 mm  
Open 100 **FD1197**



21 x 75 x 1780 mm  
Rhombus **FD1564**

Anthracite  
RAL7016



# PREMIUM

These composite wood boards are made using co-extrusion technology and are protected against insects and termites. They are protected against UV rays and are therefore guaranteed for 20 years against fading and staining.

A thin polymer layer protects these boards across the entire surface to ensure a perfect seal. For The boards can also be stiffened with aluminium reinforcements.

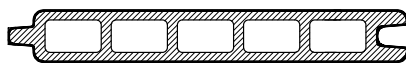

21 x 150 x 1780 mm



Dark Grey

**FD1232**



Ipe

**FD1233**



Teak

**FD1234**



Light Grey

**FD1235**



# MODERN

Using the same technology as PREMIUM boards, these composite wood boards are also protected against fading in the most extreme conditions. They stand out for their very modern design with a faux-slat effect imitating thin wooden slats.

3 colours to choose from: Teak, Dark Grey and Cedar

*These boards can also be stiffened with aluminium reinforcements.*

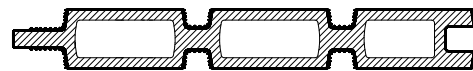

21 x 150 x 1780 mm



Teak

**FD1121**



Dark Grey

**FD1118**



Cedar

**FD1531**



# GATES

The Boston system allows you to match fences and openings with a wide range of gates.

The pre-filled gates are 980 x 1830 mm in size. They are filled with Aluminium, Premium or Modern boards, and contain the same materials as the fence, for a perfect match. The lock is integrated in the gate frame.

- Aluminium frame, powder coated in anthracite RAL7016  
Dimensions: 980 x 1830 mm.
- Vertical uprights 80 x 50 mm, horizontal crossbars 80 x 40 mm.
- Right or left-hand opening, pull or push.



PREMIUM



Also available in a customisable version (2 sizes).

MODERN



ALUMINIUM



# STRUCTURE & ACCESSORIES



**ALUMINIUM POST  
75 X 75MM**

L. 124 cm **FD1001**  
L. 184 cm **FD1002**  
L. 234 cm **FD1003**  
L. 300 cm **FD1122**



**POST CAP  
75 x 75 mm  
FD1341**



**START/END PROFILE  
25 x 30 x 1750 mm  
FD1318**



**SET OF 4 CONNECTORS FOR  
START/END PROFILE.  
FD1309**



**FINISHING PROFILE  
4 x 24 x 1840 mm  
FD1005**



**GREY STAINLESS STEEL POST  
ANCHOR  
120 x 120 x 200 mm  
FD1143**



**STAINLESS STEEL POST  
ANCHOR  
120 x 120 x 200 mm  
FD1530**



**WALL PLATE SUPPORT  
FD1340**



**CORNER KIT FOR ANGLE POST**  
Profile and associated  
hardware  
**FD1338**



**WALL PROFILE**  
28 x 24 x 1900mm (2 pcs)  
+ 12 SCREWS 4.8 x 16 mm + CAPS  
**FD1278**



**SET OF 3 ALUMINIUM  
REINFORCEMENTS FOR  
COMPOSITE FENCING**  
FD1388



**SET OF WEDGES**  
10 mm 15° (40 pcs) **FD1643**  
15 mm (66 pcs) **FD1200**  
30 mm (30 pcs) **FD1201**



**POST FOR GATE WITH CAP**  
90 x 90 x 2750 mm  
**FD1266**

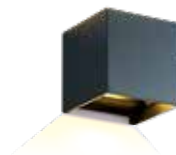

**LAKKA SPOTLIGHT**  
**6W 220V LED - WHITE WARM**  
100 x 100 x 100 mm  
**FD0995**



**CONCRETE BASE**  
35 x 200 X 1780 mm  
**FD1199**



**SPRAY**  
TEXTURED RAL 7016  
**FD1036**

# BOARDS



**ALUMINIUM BOARD**  
 21 x 75 x 1780 mm / 15° **FD1564**  
 21 x 150 x 1780 mm **FD0868**  
 21 x 100 x 1780 mm **FD1197**  
 21 x 45 x 1780 mm **FD1198**



**PREMIUM BOARD**  
 21 x 150 x 1780 mm  
 Dark Grey **FD1232** | Ipe **FD1233**  
 Teak **FD1234** | Light Grey **FD1235**



**MODERN BOARD**  
 21 x 150 x 1780 mm  
 Teak **FD1121**  
 Dark Grey **FD1118**  
 Cedar **FD1531**

# GATES



**WICKET GATES**  
 980 x 1830 mm  
 Dark Grey **FD1259** | Light Grey |  
**FD1260** | Ipe **FD1261** | Teak **FD1262**  
 | Aluminium **FD1263**



**URBAN WICKET GATE**  
 980 x 1830 mm  
 Empire Slate **FD1264**  
 Eternal Iron **FD1265**



**HARDWARE FOR  
 WICKET GATE**  
**FD1268**



**CUSTOMISABLE WICKET  
 GATE FRAME**  
 980x1830mm **FD1267**  
 1200x1830mm **FD1430**



**GATE HINGE**  
**FD1339**

# DECORS



**CRIOS HORIZONTAL DECOR**  
H 300 x L 1750 mm  
**FD1213**



**PAXOS HORIZONTAL DECOR**  
H 450 x L 1750 mm  
**FD1008**



**LAMIA HORIZONTAL DECOR**  
H 300 x L 1750 mm  
**FD1215**



**HERA HORIZONTAL DECOR**  
H 300 x L 1750 mm  
**FD1010**



**CRIOS VERTICAL DECOR**  
H 1820 x L 584 mm  
**FD1214**



**PAXOS VERTICAL DECOR**  
H 1820 x L 875 mm  
**FD1009**



**LAMIA VERTICAL DECOR**  
H 1820 x L 584 mm  
**FD1216**



**HERA VERTICAL DECOR**  
H 1820 x L 584 mm  
**FD1011**

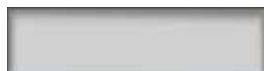

**FROSTED GLASS PANEL**  
8 X 300 X 1780 mm **FD1218**  
8 X 450 X 1780 mm **FD1219**

# AKIDO SIGHTSCREEN FENCING KIT IN COMPOSITE WOOD



## High-quality composite wood

Akido benefits from Fiberdeck's extensive know-how in the extrusion of high-quality composite wood. All our kits are guaranteed for 15 years (1). The slats are made of composite wood, which are very resistant to weather.

## Long-lasting colour with no fading

The composite wood is brushed, for a natural wood aspect. The colours are rich and can match any decor. Available in Anthracite, Brown and Sand.

## Quick and easy to install, no maintenance required

No staples, clips or screws. The elements slide in and the slats are clicked in and locked with the crossbars. Detailed instructions and a video can help guide you through the installation process.



(1) Learn more about Fiberdeck's limited guarantee on [www.fiberdeck.com](http://www.fiberdeck.com)

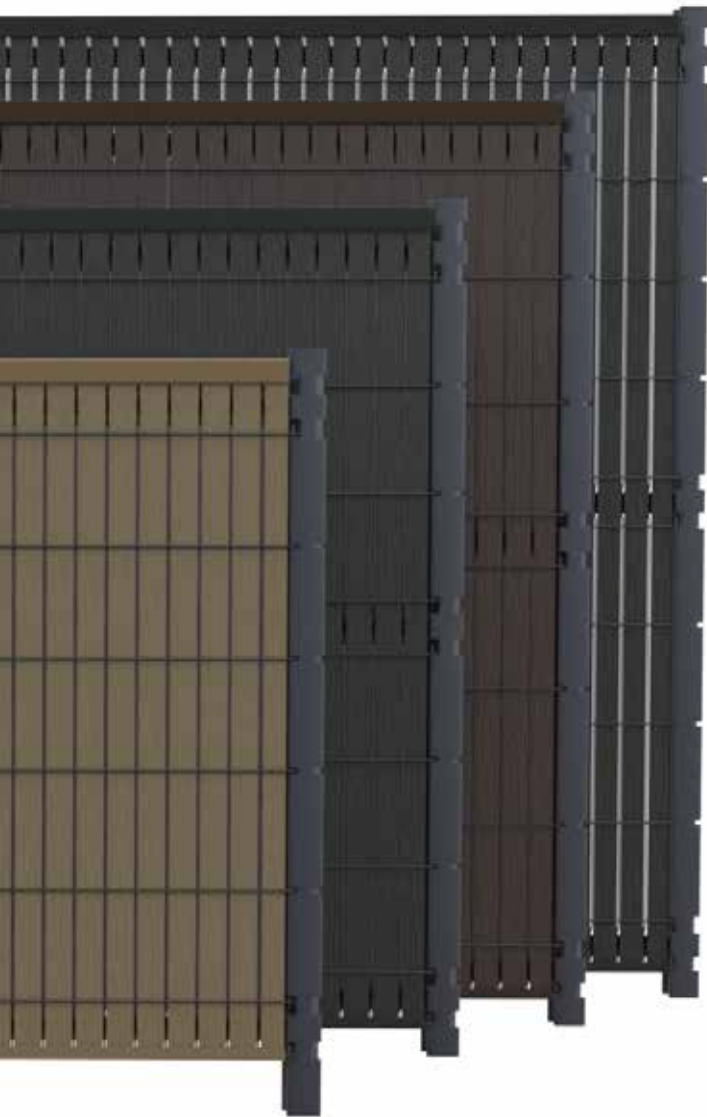

**Fiberdeck®**

# AKIDO

A universal kit for  
all 2.5m rigid fences

① Choose your  
colour



Sand    Brown    Anthracite

② Select the reinforcement  
best suited to your fence's  
V meshe

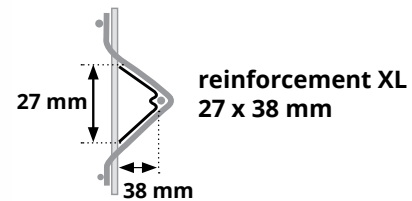
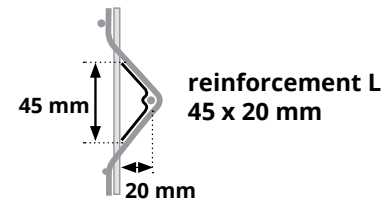
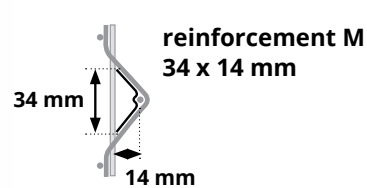

③ Choose your  
end slat

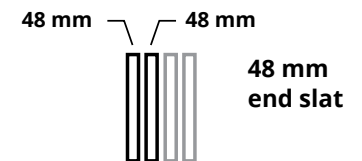
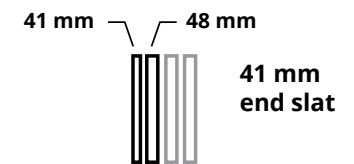





## Detailed kit contents

- 43 intermediate slats (width: 48 mm)
- 2 end slats (width: 41 mm or 48 mm)
- Reinforcements (34-14 mm or 45-20 mm)
- PVC top crossbar (aluminium optional)
- PVC bottom crossbar (aluminium optional)



Installation  
video

# SIGHTSCREEN FENCING KIT



# AKIDO

**Fiberdeck**<sup>®</sup>

Akido sight screen fencing kits are made up of opaque slats to be slid into a rigid fence. They are made of composite wood with a 15-years guarantee. Quick and easy to install, they are available in four heights and three colours. Furthermore, reinforcements that slide into the fence's V mesh are available in three different sizes.

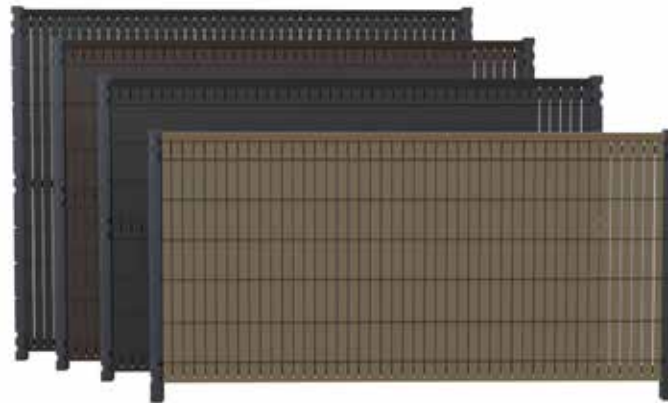

Anthracite

Brown

Sand

**A universal kit for all 2.5m rigid fences**

Available in the following heights: 1 m / 1.53 m / 1.73 m / 1.93 m

*Anthracite kit. Height: 1.93 m.*

# WEO<sup>®</sup> CO-EXTRUDED COMPOSITE CLADDING





## Guaranteed against staining and fading

With years of experience and several million square metres marketed to date in a wide range of climates, we can guarantee our products for 20 years without any visible fading.



## Unique decors and striking colours

Our co-extruded boards provide a unique experience. Their outstanding technical and aesthetic properties insure complete peace of mind for the end user.

The boards feature a matt aspect, with intense and multi-chromatic colours. Each board is unique, as the manufacturing process allows for a wide range of random shades. Thus all installed projects blend harmoniously into their environment.



# WEO®

**Fiberdeck®**

## Biosourced cladding with unrivalled performance

WEO® cladding boards have been developed using the latest co-extrusion technologies to guarantee a fading-free product for 20 years while using 95% waste in its manufacture! A waterproof polyethylene film protects the wood from moisture absorption and stabilises the material. Furthermore, expansion is reduced to a minimum.



The mark of responsible forestry

# WEO® Classic



## A CLADDING BOARD WITH INTENSE AND BRIGHT COLOURS !

WEO® Classic cladding boards are available in 4 multi-coloured shades that are guaranteed against fading.

They confer a unique shine to your facade. The very durable brushed and matt surface beautifully imitates natural wood !





WEO® CLASSIC CLADDING BOARD  
13 x 173 mm x 3.6 m

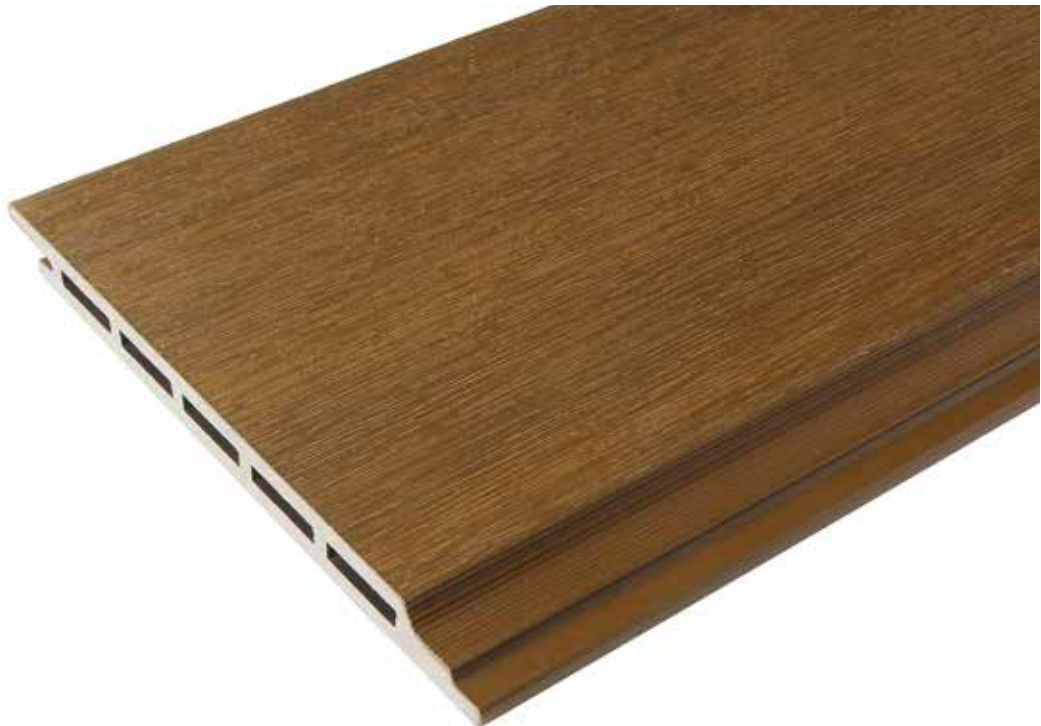

Teak  
FD1082



Ipe  
FD1083



Light Grey  
FD1084



Dark Grey  
FD1085



ALUMINIUM U STARTING PROFILE (2 PCS)

25 x 0,7 mm x 3 m  
FD1090



ALUMINIUM F PROFILE

35 x 45 mm x 3,60 m

FD1086 | ■ Teak  
FD1087 | ■ Ipe

FD1088 | ■ Light Grey  
FD1089 | ■ Dark Grey



WEO® CLASSIC STAINLESS STEEL CLIP  
(100 PCS) + SCREW

9 m<sup>2</sup>  
FD1091



WEO® CLASSIC STAINLESS STEEL SCREWS  
(100 PCS)

For vertical installation | 20 m<sup>2</sup>

FD1313 | ■ Teak  
FD1314 | ■ Ipe

FD1315 | ■ Light Grey  
FD1316 | ■ Dark Grey

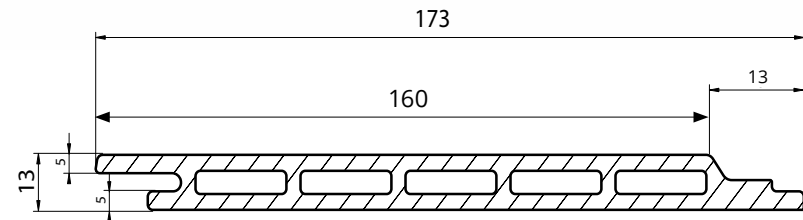

Usable surface per board	0,5832 m <sup>2</sup>
Mass per unit area	10,3 kg/m <sup>2</sup>
Outer width	173 mm
Usable width	162 mm
Standard length	3600 mm

# WEO<sup>®</sup> 35



## A CONTEMPORARY SLATTED DECOR

WEO<sup>®</sup> 35 slatted boards offer unparalleled durability. They give your facade a chic, modern look in matt wood colours without any fading or maintenance.



**WEO® 35 CLADDING BOARD**

33 x 170 mm x 2.9 m | 33 x 170 mm x 3.9 m



**NEW**



**Cedar**  
2.9 m FD1544  
3.9 m FD1548



**Teak**  
2.9 m FD1541  
3.9 m FD1545



**Ipe**  
2.9 m FD1542  
3.9 m FD1546



**Dark Grey**  
2.9 m FD1543  
3.9 m FD1547



**ALUMINIUM F PROFILE**

65 x 80 mm x 3,60 m

FD1428 | Cedar  
FD0967 | Teak

FD0968 | Ipe  
FD0970 | Dark Grey



**STAINLESS STEEL SR2 SCREW  
(BOX OF 100 PCS) + END CAPS**

4,2 x 38 mm | 6 m<sup>2</sup>

FD1451 | Cedar  
FD1447 | Teak

FD1448 | Ipe  
FD1450 | Dark Grey

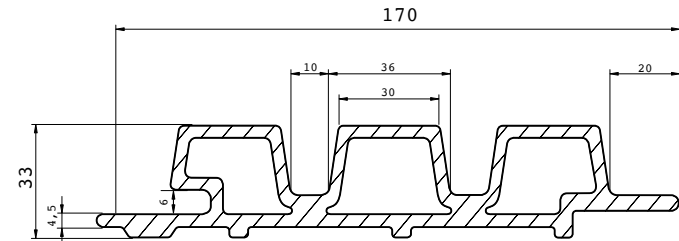

	Length 2.9 m	Length 3.9 m
Usable surface per board	<b>0,406 m<sup>2</sup></b>	<b>0,546 m<sup>2</sup></b>
Mass per unit area	<b>15 kg/m<sup>2</sup></b>	<b>15 kg/m<sup>2</sup></b>
Outer width	<b>170 mm</b>	<b>170 mm</b>
Usable width	<b>140 mm</b>	<b>140 mm</b>

# WEO® 60



## A MODERN SLATTED DECOR

WEO® 60 cladding boards feature a slatted design and can be installed quickly horizontally or vertically. The 60mm-wide boards are evenly spaced 10mm apart. They are lightweight, stable and easy to install with our mounting system. These boards can also be combined with WEO® 35 and WEO® 60 profiles to create more variations, or paired with any other modern material.



**WEO® 60 CLADDING BOARD**

33 x 170 mm x 2.9 m | 33 x 170 mm x 3.9 m



**Cedar**  
2.9 m FD1567  
3.9 m FD1571



**Teak**  
2.9 m FD1565  
3.9 m FD1569



**Ipe**  
2.9 m FD1566  
3.9 m FD1570



**Dark Grey**  
2.9 m FD1568  
3.9 m FD1572



**ALUMINIUM F PROFILE**

65 x 80 mm x 3,60 m

- FD1428 | Cedar
- FD0967 | Teak
- FD0968 | Ipe
- FD0970 | Dark Grey

**STAINLESS STEEL SR2 SCREW (BOX OF 100 PCS) + END CAPS**

4,2 x 38 mm | 6 m<sup>2</sup>

- FD1451 | Cedar
- FD1447 | Teak
- FD1448 | Ipe
- FD1450 | Dark Grey



**WEO® 60 STAINLESS STEEL SCREWS FOR CONCEALED INSTALLATION**

4.2 x 32 mm | 500 pcs + end caps

FD1337

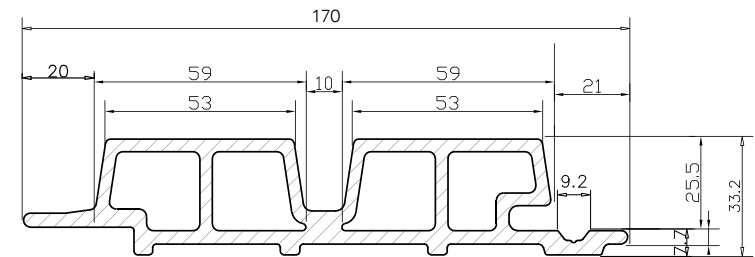

	Length 2.9M	Length 3.9M
Usable surface per board	0,406 m <sup>2</sup>	0,546 m <sup>2</sup>
Mass per unit area	14,5 kg/m <sup>2</sup>	14,5 kg/m <sup>2</sup>
Outer width	170 mm	170 mm
Usable width	140 mm	140 mm

# WEO<sup>®</sup> Brise-soleil



## A SET OF WOODEN BOARDS FOR PROTECTION FROM THE SUN !

These composite wood sunshades offer effective protection from the sun. By adjusting the spacing between the boards, they allow shadows to play on the facade and provide excellent heat insulation. A unique and contemporary wood decor that does not age

# Fiberdeck®



Teak



Ipe



BRISE-SOLEIL BOARD	Teak	Ipe
42 x 60 mm x 4 m	FD1092	FD1093
52 x 100 mm x 4 m	FD1094	FD1095
62 x 120 mm x 4 m	FD1096	FD1097



END CAP	Teak	Ipe
42 x 60 mm (x24)	FD1098	FD1099
52 x 100 mm (x10)	FD1100	FD1101
62 x 120 mm (x6)	FD1102	FD1103



**1** ALUMINUM STAPLE - NV3 Adjustable  
FD1154



**2** CROSSBAR KX-3000 RAL9005  
FD1156



**3** WEDGE - Thermal break pad  
FD1157



**4** A2 STAINLESS STEEL SCREW - self-drilling  
5,5 x 32 mm FD1155    5,5 x 50 mm FD1223  
5,5 x 38 mm FD1222    5,5 x 60 mm FD1224

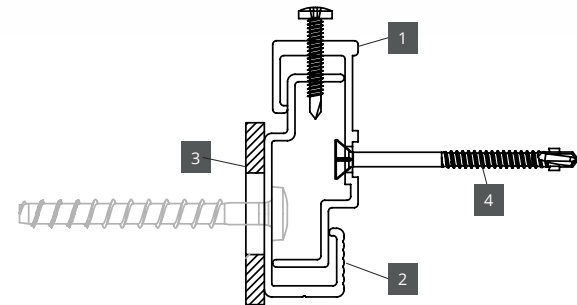

# WEO<sup>®</sup> Classic

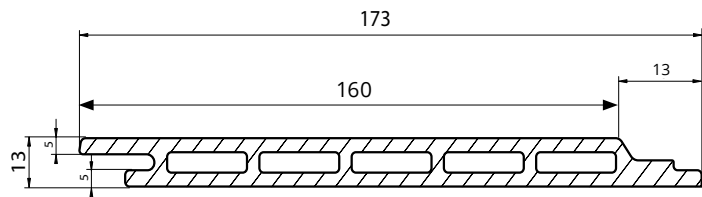

Usable surface per board	0,5832 m <sup>2</sup>	
Mass per unit area	10,3 kg/m <sup>2</sup>	
Outer width	173 mm	
Useful width	162 mm	
Standard length	3600 mm	
	Qty of clips / m <sup>2</sup>	Qty of clips / board of 3.6 m
Span 600 mm	11	7

# WEO<sup>®</sup> 35

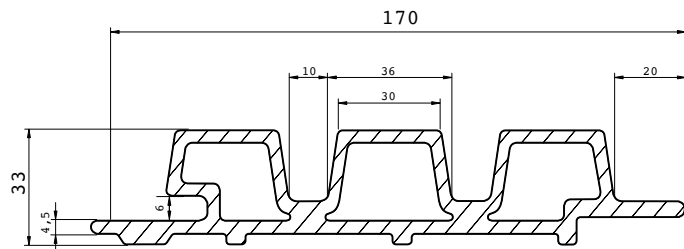

Standard length	2900 mm	3900 mm
Usable surface per board	0,406 m <sup>2</sup>	0,546 m <sup>2</sup>
Mass per unit area	15 kg/m <sup>2</sup>	15 kg/m <sup>2</sup>
Outer width	170 mm	170 mm
Useful width	140 mm	140 mm
Qty of screws / m <sup>2</sup> (600mm span)	12	12
Qty of screws / board (600 mm span)	5	7

# WEO<sup>®</sup> 60

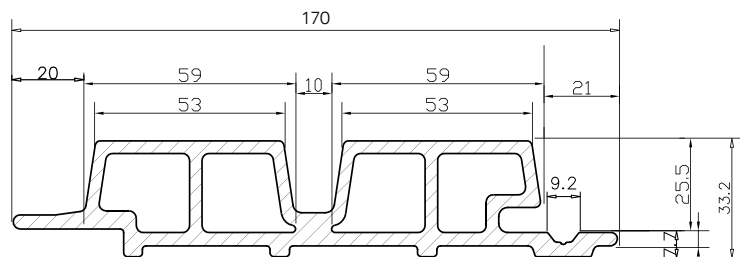

Standard length	2900 mm	3900 mm
Usable surface per board	0,406 m <sup>2</sup>	0,546 m <sup>2</sup>
Mass per unit area	14,5 kg/m <sup>2</sup>	14,5 kg/m <sup>2</sup>
Outer width	170 mm	170 mm
Useful width	140 mm	140 mm
Qty of screws / m <sup>2</sup> (600 mm span)	12	12
Qty of screws / board (600 mm span)	5	7



# WEO<sup>®</sup> Brise-Soleil

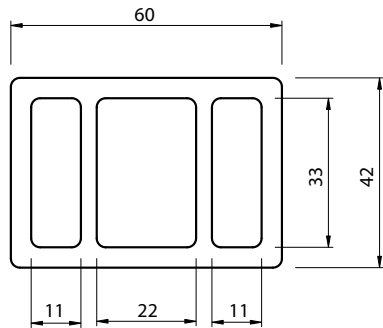

Weight / Linear metre	1,75 kg
Outer width	60 mm
Outer height	42 mm
Standard length	4 m

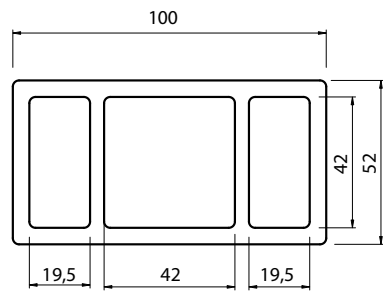

Weight / Linear metre	3 kg
Outer width	100 mm
Outer height	52 mm
Standard length	4 m

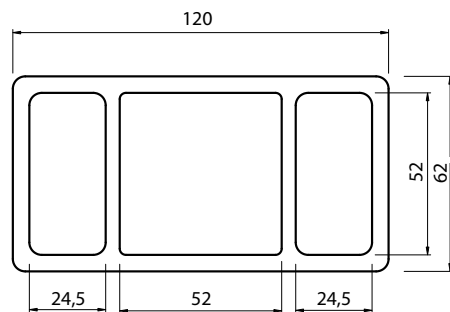

Weight / Linear metre	3,70 kg
Outer width	120 mm
Outer height	62 mm
Standard length	4 m

# WEO<sup>®</sup> Classic

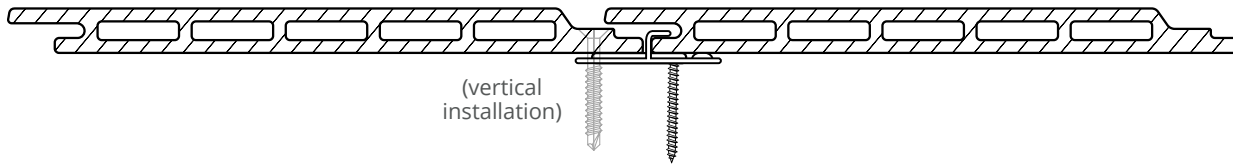

CLIP FASTENING

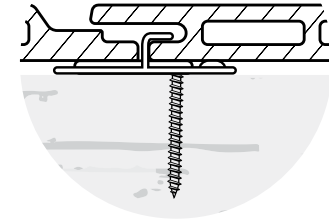

# WEO<sup>®</sup> 35

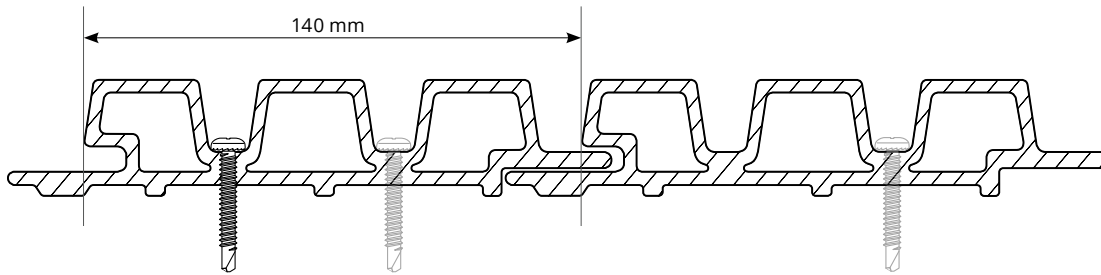

SCREW FASTENING

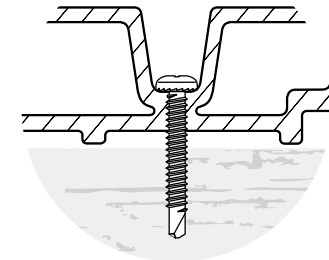

# WEO<sup>®</sup> 60

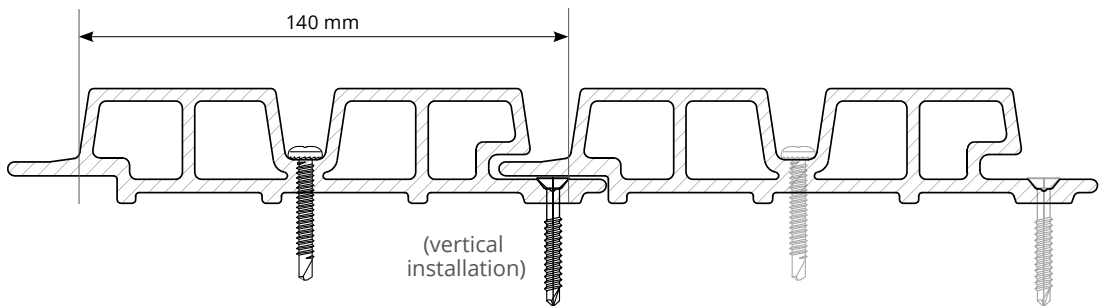

SCREW FASTENING

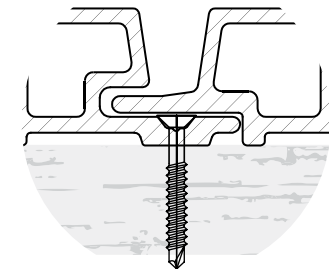

# WEO<sup>®</sup> Brise-Soleil

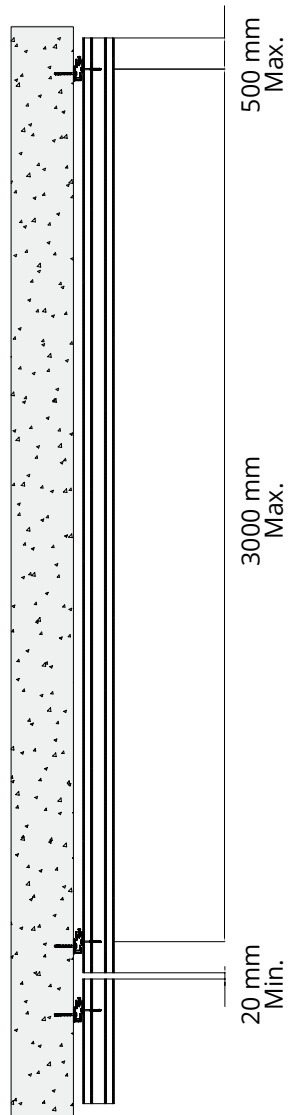

STAPLE FIXING ON CROSSBAR

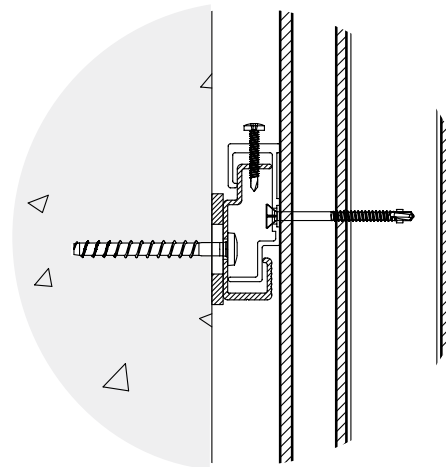

VERTICAL INSTALLATION

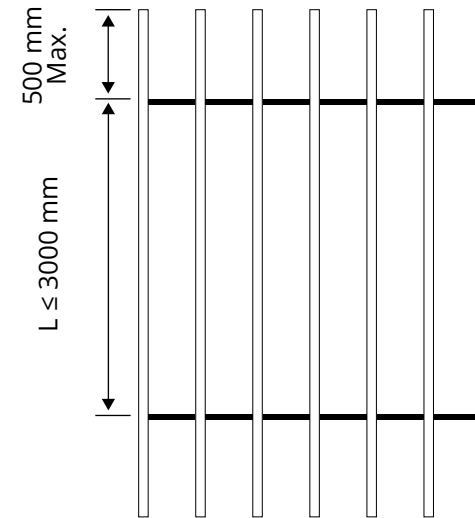

HORIZONTAL INSTALLATION

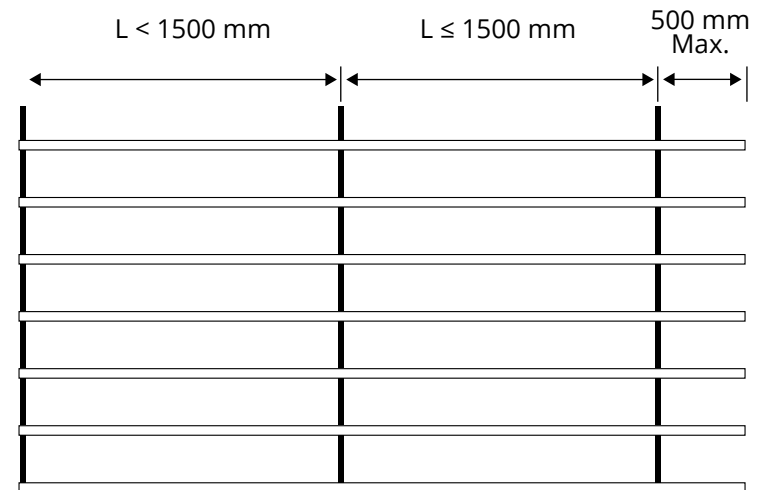

**Fiberdeck<sup>®</sup>**

[fiberdeck.com](http://fiberdeck.com)