



**Fiberdeck**<sup>®</sup>

COMPOSITE  
FENCING

BOSTON

# OUR ENGAGEMENTS

**Fiberdeck**<sup>®</sup>

Driven by a pioneering spirit, we are proud to be the forerunners of co-extruded wood plastic composite.

This material with its exceptional properties has an unequalled durability, does not stain or discolour.

We use 95% recycled material in the manufacture of our wood composite, which allows us to store used plastics and carbon in a sustainable way.

Our wood fibres and dust are ethically and sustainably resourced, as they are residual flows from furniture production.

We design to last, that's our promise.









**Fiberdeck**<sup>®</sup>

# THE BOSTON CONCEPT

Boston is an ecosystem of products designed to adapt to your environment, your needs and your desires. The posts are fixed in the ground, on a slab or low wall and the fence is easily assembled by interlocking.





# My Fence Planner

## A SEAMLESS EXPERIENCE

MyFencePlanner is our online tool that will allow you to design your project and get an indicative offer

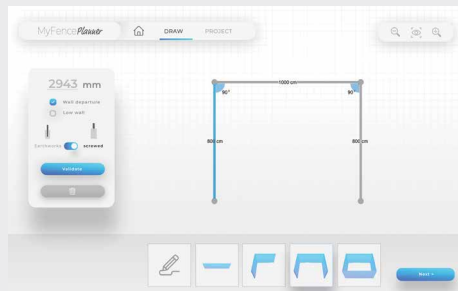

1.

### Draw the outline of the project

Unique support tool in myfenceplanner is the possibility to search the address of the project and to draw the plan directly on a satellite image

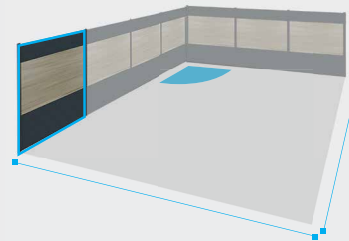

2.

### Create your own fence.

All the collections are available and immediately find the style that suits

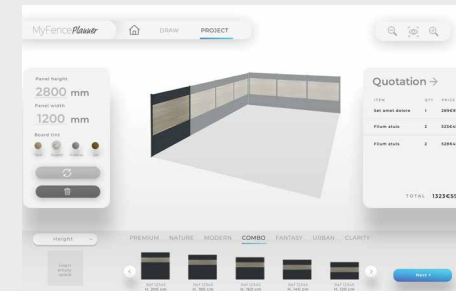

3.

### Download the offer.

An estimate of the recommended retail price is available

[En.myfenceplanner.com](https://en.myfenceplanner.com)

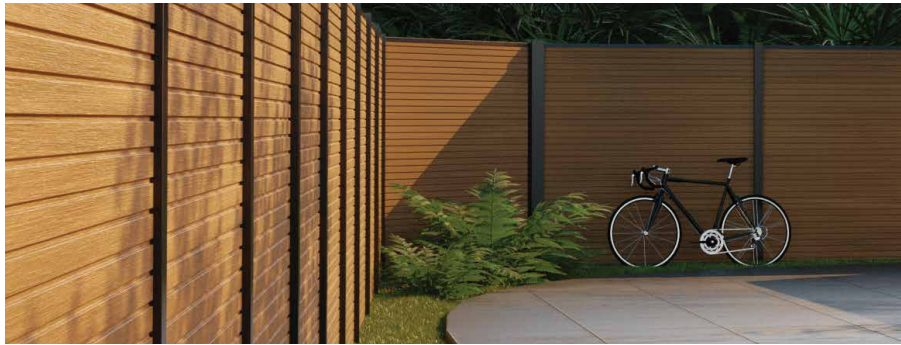

MODERN **P.9**



PREMIUM **P.11**



COMBO **P.13**



NATURE **P.15**

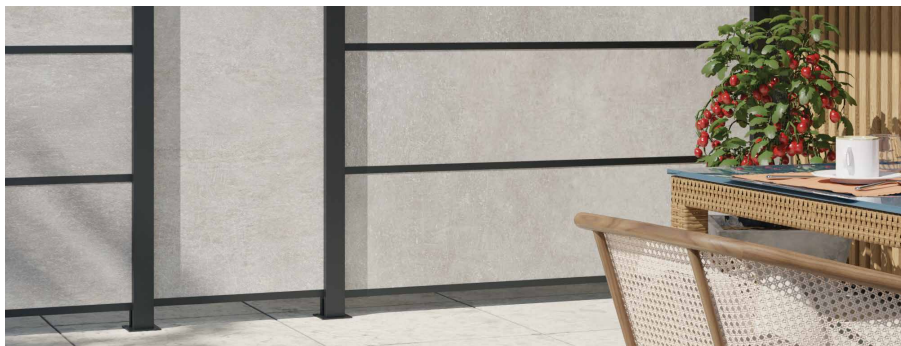

URBAN **P.17**





CRIS P.19



HERA P.21

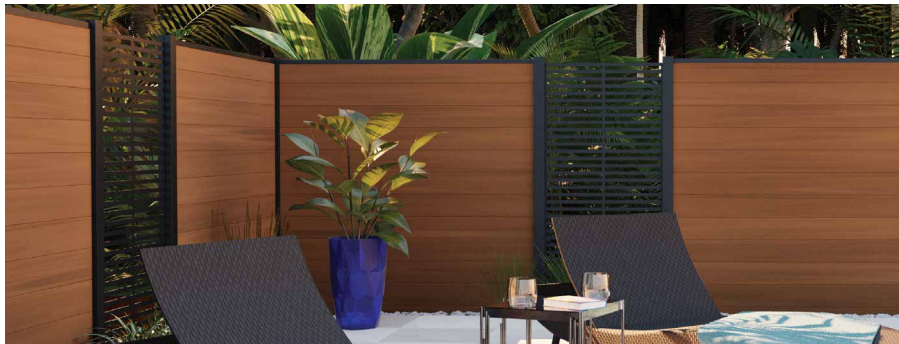

PAXOS P.23



LAMIA P.25

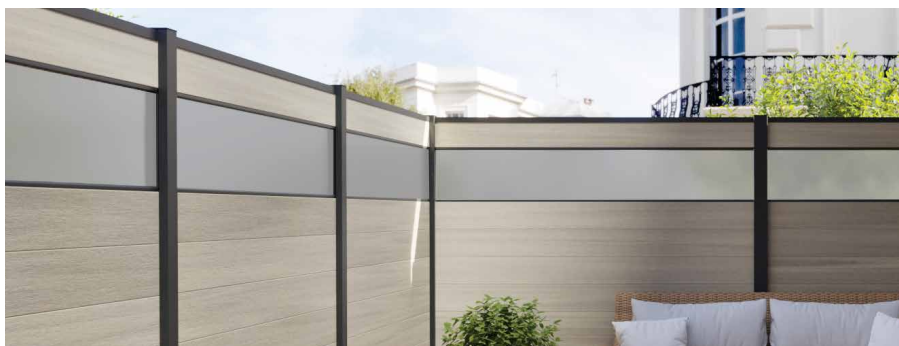

CLARITY P.27



OPEN P.29

# MODERN

**Fiberdeck**<sup>®</sup>

The MODERN slat's grooves carefully calibrated proportions create an elegant, slatted look. The wood composite boards are guaranteed not to fade under the most extreme conditions, thanks to the co-extrusion process.

- *The boards can also be stiffened with aluminium reinforcements*
- *Also available is the corner kit system for creating a completely free contour*

Dark Grey

**REF. 2341**

Teak

**REF. 2343**



*Modern Teak slats*







MODERN  
COLLECTION



PREMIUM  
COLLECTION





# PREMIUM

**Fiberdeck**<sup>®</sup>

As a result of extensive research and development, our Premium boards are guaranteed protected against insects and termites. They are insensitive to the sun's UV and are therefore guaranteed for 20 years against fading and staining.

A thin layer of polymer protects the entire surface to ensure a perfect seal.

• *These boards can also be stiffened with aluminium reinforcements*



Dark Grey

**REF. 2315**



Teak

**REF. 2317**



Light Grey

**REF. 2316**



Ipe

**REF. 1726**



*Premium Dark Grey slats*

# COMBO

**Fiberdeck**<sup>®</sup>

Warmth and modernity define the Combo collection. Mix anthracite aluminium slats with WPC boards to create a bright contrast or a subtle play of textures.

## IN POSSIBLE COMBINAISON WITH :



Dark Grey

**REF. 1232**



Teak

**REF. 1234**



Light Grey

**REF. 1235**



Ipe

**REF. 1233**



*Mix of Premium Light Grey slats and Aluminium slats*







COMBO  
COLLECTION



NATURE  
COLLECTION





# NATURE

**Fiberdeck**<sup>®</sup>

The Nature plank is made of bio-based materials from 60% wood fibre and 40% recycled polyethylene.

They are resistant to insect and termite attack and extreme weather conditions without treatment. They are available in two colours: Anthracite and Platinum.

Anthracite

**REF. 2339**

Platinum

**REF. 2340**



*Nature Platinum Slats  
Customisable gate filled with Platinum slats  
Concrete base plates*

# HPL

**Fiberdeck**<sup>®</sup>

For the most modern environments, opt for HPL panels. Used by architects to clad the facades of ever more audacious buildings, this material will naturally find its place on a rooftop, a terrace or any contemporary environment.

Empire Slate

**Ref. 2528 (horizontal)**  
**Ref. 2705 (vertical)**

Eternal Iron

**Ref. 2529 (horizontal)**  
**Ref. 2706 (vertical)**



*HPL empire slate horizontal and vertical panels*





URBAN  
COLLECTION



FANTASY  
COLLECTION





# CRIOS

**Fiberdeck**<sup>®</sup>

A breathtaking view of a dewy sky. A moment that will remain frozen for eternity. Crios is a laser-cut aluminium set, the pattern of which will evoke a giant set of bricks that will let the light and the landscape through while providing privacy.

- *The perimeter frame elements ensure perfect integration with the panel and a perfect finish*
- *A wall plate support is also available for fixing to a wall without grouting or cracking, which distributes the fixing forces*



**CRIOS VERTICAL DECOR**  
H 1820 x L 584 mm  
**Ref. 2532**



**CRIOS HORIZONTAL DECOR**  
H 300 x L 1750 mm  
**Ref. 2531**

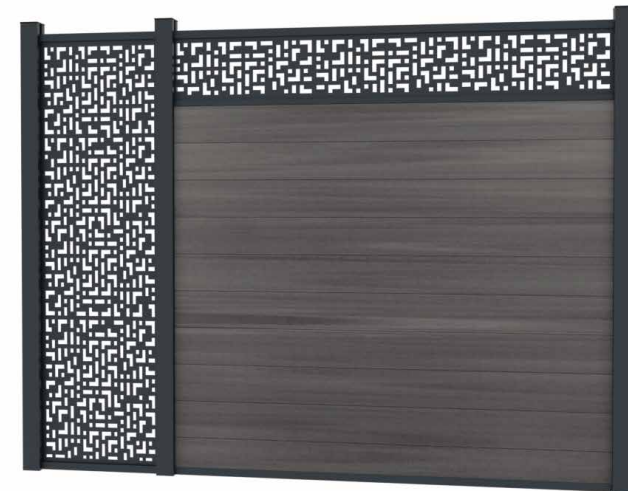

*Premium Light Grey slats and Crios horizontal decor.  
Mounting on wall plate support*

# HERA

**Fiberdeck**<sup>®</sup>

Intertwined with lines of varying thickness, the Hera decor is remarkably balanced and will look good in the city as well as in the country.

- *The decors are offered with a grooved aluminium frame that fits perfectly on the aluminium or composite slats and in the rebates of the posts*



**HERA VERTICAL DECOR**  
H 1820 x L 584 mm  
**Ref. 2333**



**HERA HORIZONTAL DECOR**  
H 300 x L 1750 mm  
**Ref. 2334**



*Light Grey slats and horizontal Hera décor*





FANTASY  
COLLECTION



FANTASY  
COLLECTION





# PAXOS

**Fiberdeck**<sup>®</sup>

An orange light that tears through our Paxos sets, forming a subtle and regular shadow play.

- The 3mm thick, powder-coated decors are delivered with an aluminium frame which is assembled on the aluminium or composite slats and in the posts



**PAXOS VERTICAL DECOR**  
H 1820 x L 875 mm  
Ref. 2335



**PAXOS HORIZONTAL DECOR**  
H 450 x L 1750 mm  
Ref. 2336



*Premium Teak slats and vertical Paxos décor*

# LAMIA

**Fiberdeck**<sup>®</sup>

The surprisin effect of the Lamia decor is reminiscent of foam on the sea, even in the middle of the desert. Thanks to its powder-coated aluminium structure, the Lamia collection will last for years.



**LAMIA VERTICAL DECOR**  
H 1820 x L 584 mm  
**Ref. 2534**



**LAMIA HORIZONTAL DECOR**  
H 300 x L 1750 mm  
**Ref. 2533**



*Premium Teak slats and Lamia decors vertical  
and horizontal*





FANTASY  
COLLECTION



CLARITY  
COLLECTION





# CLARITY

**Fiberdeck**<sup>®</sup>

The Clarity frosted glass panels allow light to pass through while maintaining privacy.

8mm thick frosted glass panels are combined with composite or aluminium slats to form modern and stylish filter panels.

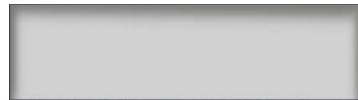

**FROSTED GLASS PANEL**

8 X 300 X 1780 mm **Ref. 2535**

8 X 450 X 1780 mm **Ref. 2536**



*Premium light grey slats  
and 300mm high frosted glass panel*

# OPEN

**Fiberdeck**<sup>®</sup>

In full-height panels to accommodate climbing plants or as an openwork finish on solid panels, OPEN slats are installed using suitable wedges to ensure a perfect finish.

- *Qualicoat certified, the aluminium slats, as well as the posts and decorations, are powder coated (RAL7016). They therefore have excellent durability and good resistance to the elements.*
- *Slats and wedges are available in 2 heights and adjustable in width, allowing the opening level to be adapted*
- *They also allow a certain level of shading to be maintained while still allowing the wind to pass through. The effect is remarkable on a low wall*

Anthracite



**Aluminium Slats**  
21 x 100 x 1780mm + cales  
**Ref. 2522 / Ref. 2525**

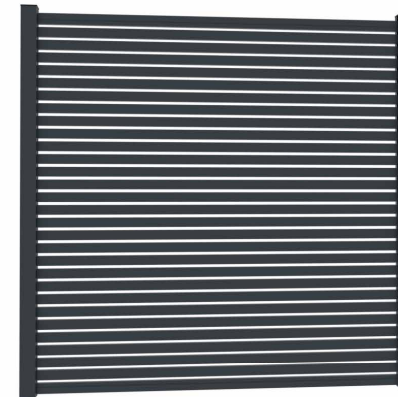

**Aluminium Slats**  
21 x 45 x 1780mm + cales  
**Ref. 2523 / Ref. 2524**

*Open 100mm slats and 30mm aluminium wedges.  
Fixing on a low wall*







OPEN  
COLLECTION





# POSTS

The quality and strength of the structural elements are at the heart of Boston's engineering.

The posts are the best example of this. The H-shaped profile naturally allows for a straight or 90° bifurcated course. The thickness of the aluminium is up to 2.2mm.

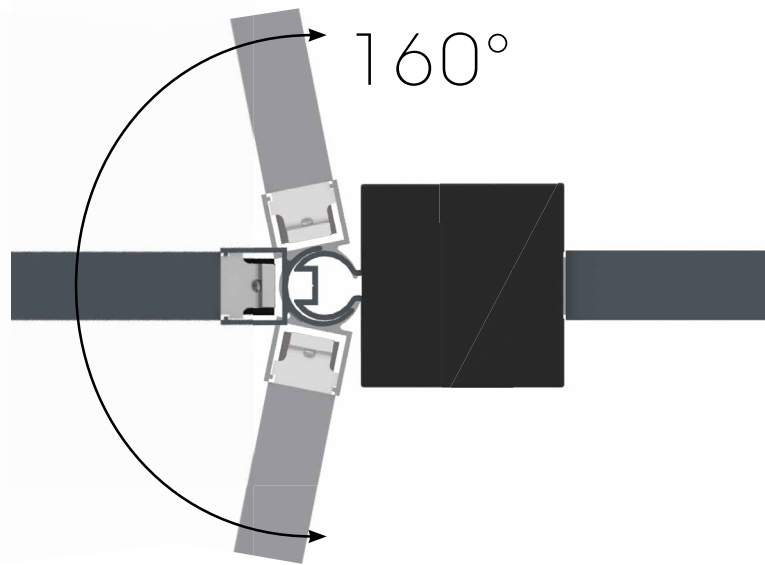

## NEW IDEAS ANGLE POST

**The rebate of the posts already accommodates rails and finishing profiles, and now an innovative pivot system.**

**An axis is clipped into the rebate of the post, and the pivot slides over it. The pivoting part will receive the slats like a normal post. It is possible to create angles from 10° to 170°. The whole is held in position with the associated screws and closed with a specially designed cap.**



**High streamlined hinge  
adjustable**



**Reinforced sealing post with 90x90mm  
section. Thickness 4mm  
Associated with profile Ref. 1278, it  
allows the wicket to be inserted into  
the fence without an additional post**

**Adjustable crapaudine  
Pivot on bearing**



**Mortise reversible  
bolt lock**



**Stopper with keeper  
adaptable**



# GATES

The Boston system allows you to match fences and openings with a wide range of gates.

The pre-filled gates have the dimensions 980\*1830mm. They are filled with Aluminium, Premium or HPL panels. They are filled with the same materials as the fence, for a perfect match. The lock is integrated in the gate frame.

## FEATURES

- Aluminum frame painted anthracite RAL7016  
Dimensions 980x1830mm or 1200x1830mm
- 80x50mm vertical uprights, horizontal crossbars 80x40mm
- Width adjustment possible: 120cm maximum.
- Right or left hand opening, pull or push



ALUMINIUM

Anthracite **Ref. 2541**



PREMIUM

Dark Grey **Ref. 2537**  
Light Grey **Ref. 2538**

Ipe **Ref. 2539**  
Teak **Ref. 1240**



URBAN

Empire Slate **Ref. 2542**  
Eternal Iron **Ref. 2543**



# CUSTOMISABLE GATE

Opting for a wicket door frame allows you to adjust the width of the door exactly for any opening up to 120cm, and to customise the filling by purchasing the slats separately. The lock is integrated in the wicket door frame.

The gate frame is available in two sizes:

- 980x1830mm **Ref. 2698**
- 1200x1830mm **Ref. 2697**

## FASTENERS AND HARDWARE

- Wicket door hardware, sold separately for pre-filled wickets and fillable wickets. Includes handles, top hinge, catch, stop, lock cylinder **Ref. 2544**
- A steel post with a section of 90x90mm and an unequalled thickness of 4mm **Ref. 2327**
- Hinge to be fixed on a wall or post, if the clamp is not suitable (e.g. loose floor) **Ref. 2670**







# ALUMINIUM

Qualicoat certified, the aluminum slats, like the posts and the decorations are epoxy powder coated (RAL7016). They thus benefit from excellent resistance over time and good resistance to bad weather. These slats combine harmoniously with composite slats and decors to create structured patterns.



21 x 150 x 1780 mm



21 x 100 x 1780 mm



21 x 45 x 1780 mm

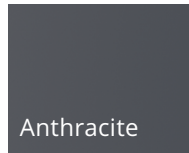

Anthracite

21 x 150 x 1780 mm

**Ref. 2188**

21 x 100 x 1780mm

**Ref. 2522**

21 x 45 x 1780mm

**Ref. 2523**



# MODERN

Using the same technology as PREMIUM boards, these wood composite boards are also guaranteed against fading under the most extreme conditions. They have a very modern look with a very contemporary mock-slat appearance.

Available in a choice of 2 colours: Teak and Dark Grey.

These slats can also be stiffened with aluminium reinforcements.

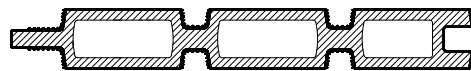

21 x 150 x 1780 mm



Teak

**Ref. 2343**



Dark Grey

**Ref. 2341**





# PREMIUM

The latest co-extrusion technology ensures that these composite wood planks are not only guaranteed against insect and termite attack, but also against the sun's UV rays and are therefore guaranteed for 20 years against fading and staining.

A thin layer of polymer protects them over the entire surface to ensure a perfect seal. Finally, to give the fence extra strength, the slats can be stiffened with aluminium reinforcements.

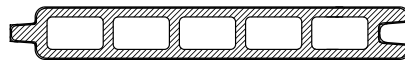

21 x 150 x 1780 mm



**Ref. 2315**



**Ref. 1726**



**Ref. 2317**



**Ref. 2316**

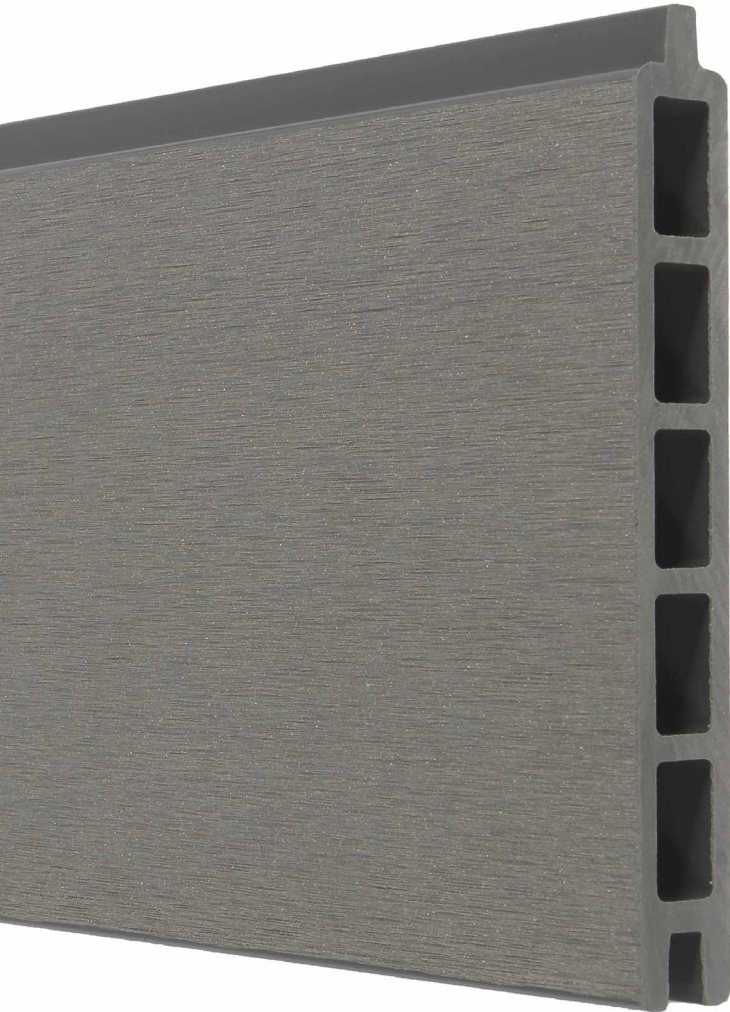

# NATURE

NATURE wood composite slats are made of bio-based materials from 60% wood fibres and 40% recycled polyethylene. They are naturally resistant to insect and termite attack and extreme weather conditions without treatment.

They are available in two colours: Anthracite and Platinum.

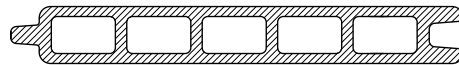

21 x 150 x 1780 mm



Anthracite

**Ref. 2339**

Platinum

**Ref. 2340**





# HPL

HPL is a composite material made of paper impregnated with thermosetting resin, heated and pressurised. Perfectly suited for outdoor use, the decorations applied to the sides are also resistant to UV and stain resistant...



8 x 430 x 1770 mm / horizontal

Empire Slate

**Ref. 2528**

Eternal Iron

**Ref. 2529**



8 x 650 x 1800 mm / vertical

Empire Slate

**Ref. 2705**

Eternal Iron

**Ref. 2706**



Collection : **Fantasy**  
Slats : **Premium Dark Grey**  
Decor : **Hera**  
Pose : **vertical**



Collection : **Fantasy**  
Slats : **Premium Dark Grey**  
Decor : **Crios**  
Pose : **horizontal**



Collection : **Fantasy**  
Slats : **Premium Dark Grey**  
Decor : **Paxos**  
Pose : **horizontal**



Collection : **Fantasy**  
Slats : **Premium Dark Grey**  
Decor : **Lamia**  
Pose : **vertical & horizontal**





Collection : **Combo**  
Slats : **mix Alu / Premium**  
**Light Grey**



Collection : **Combo**  
Slats : **mix Alu / Premium**  
**Light Grey**  
Accessories : **Spot Lakka**



Collection : **Combo**  
Slats : **mix Alu / Premium**  
**Light Grey**



Collection : **Combo**  
Slats : **mix Alu / Premium**  
**Light Grey**



Collection : **Open**  
Slats : **Mix Alu / Open**



Collection : **Open**  
Slats : **Mix Alu / Premium Dark Grey**



Collection : **Open**  
Slats : **Mix Alu / Premium Dark Grey**



Collection : **Clarity**  
Slats : **Premium Dark Grey**  
Pose : **horizontal**





Collection : **Urban**  
Slats : **HPL Empire Slate**  
Pose : **Horizontal & vertical**



Collection : **Urban / Clarity**  
Slats : **HPL Eternal Iron**  
Pose : **horizontal**

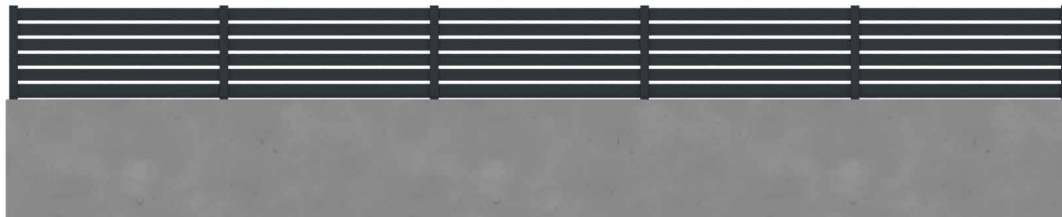

Collection : **Open**  
Slats : **Aluminium**  
Pose : **horizontal on low wall**

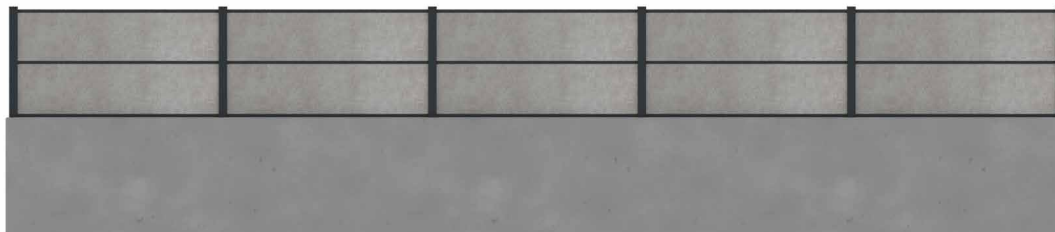

Collection : **Urban**  
Slats : **HPL Empire Slate**  
Pose : **horizontal on low wall**

# STRUCTURE & ACCESSORIES



**ALUMINIUM POST  
(H OU U) 75 X 75 MM**  
L 124 cm **Ref. 2202**  
L 190 cm **Ref. 2546**  
L 250 cm **Ref. 2547**  
L 300 cm **Ref. 2337**



**POST CAP**  
75 x 75 mm  
**Ref. 2658**



**JEU DE CALES**  
15 mm (66 pcs) **Ref. 2524**  
30 mm (30 pcs) **Ref. 2525**



**POST ANCHOR**  
120 x 120 x 200 mm  
**Ref. 2497**



**CONCRETE BASE**  
35 x 200 X 1780 mm  
**Ref. 1199**

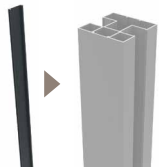

**FINITION PROFILE**  
L 190 cm **Ref. 2620**  
L 234 cm **Ref. 2576**



**START/END PROFILE**  
25 x 30 x 1750 mm  
**Ref. 2644**  
**SET OF 4 CONNECTORS  
FOR TOP/BOTTOM RAILS**  
**Ref. 2645**



**WALL PROFILE**  
28 x 24 x 1900 mm (2 pcs)  
+ 12 SCREWS 4,8 x 16 mm  
**Ref. 2647**  
**PROFILE MONTAGE SET**  
**Ref. 2646**



**METAL REINFORCEMENT  
FOR FENCE 12X20MM - 1.75M  
(3PCS)**  
**Ref. 1991**





**WALL ANCHOR SUPPORT**  
Ref. 2651



**KIT FOR ANGLE POST**  
Ref. 2648



**POST FOR GATE**  
90 x 90 x 2750 mm  
Ref. 2327

**PVC CAPS**  
Ref. 1784



**HORIZONTAL HPL KIT**  
Ref. 2530



**VERTICAL HPL KIT**  
Ref. 2659

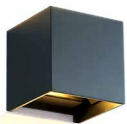

**LAKKA LIGHT 100X100 6W-220V**  
**WARM WHITE**  
100 x 100 x 100 mm  
Ref. 2332

# PANELS



**ALUMINIUM FENCING BOARD**  
 21 x 150 x 1780 mm **Ref. 0868**  
 21 x 100 x 1780 mm **Ref. 1197**  
 21 x 45 x 1780 mm **Ref. 1198**



**WPC FENCE BOARD NATURE**  
 21 x 150 x 1780 mm  
 Anthracite **Ref. 1237**  
 Platinum **Ref. 1236**



**WPC FENCE BOARD PREMIUM**  
 21 x 150 x 1780 mm  
 Dark Grey **Ref. 1232** | Ipe **Ref. 1233**  
 Teak **Ref. 1234** | Light Grey **Ref. 1235**



**WPC FENCE BOARD MODERN**  
 21 x 150 x 1780 mm  
 Teak **Ref. 1121**  
 Dark Grey **Ref. 1118**



**PANELLING HPL**  
 1770 X 430 X 8 MM  
 Empire Slate **Ref. 2528**  
 Eternal Iron **Ref. 2705**  
 650 X 1800 X 8 MM  
 Empire slate **Ref. 2529**  
 Eternal Iron **Ref. 2706**

# GATES



**GATES**  
 980 x 1830 mm  
 Ipe **Ref. 1261-2539** | Teak **Ref. 1262-2540**  
 Light Grey **Ref. 1260-2538** | Dark Grey  
**Ref. 1259-2537** | Aluminim **Ref. 1263-2541**



**URBAN GATE**  
 980 x 1830 mm  
 Empire Slate **Ref. 1264-2542**  
 Eternal Iron **Ref. 1265-2543**



**HARDWARE FOR GARDEN DOOR**  
**Ref. 2544**



**DOOR FRAME**  
 980x1830mm **Ref. 1267-2698**  
 1200x1830mm **Ref. 1430-2697**



**TOP / BOTTOM GATE HINGE**  
**Ref. 2670**

# DECORS



**CRIOS HORIZONTAL DECOR**  
H 300 x L 1750 mm  
**Ref. 2531**



**PAXOS HORIZONTAL DECOR**  
H 450 x L 1750 mm  
**Ref. 2335**



**LAMIA HORIZONTAL DECOR**  
H 300 x L 1750 mm  
**Ref. 2533**



**HERA HORIZONTAL DECOR**  
H 300 x L 1750 mm  
**Ref. 2333**



**CRIOS VERTICAL DECOR**  
H 1820 x L 584 mm  
**Ref. 2532**



**PAXOS VERTICAL DECOR**  
H 1820 x L 875 mm  
**Ref. 2335**



**LAMIA VERTICAL DECOR**  
H 1820 x L 584 mm  
**Ref. 2534**



**HERA VERTICAL DECOR**  
H 1820 x L 584 mm  
**Ref. 2335**



**GLASS PANEL**  
8 X 300 X 1780 mm **Ref. 2535**  
8 X 450 X 1780 mm **Ref. 2536**



**Fiberdeck**<sup>®</sup>

[fiberdeck.com](https://fiberdeck.com)