

FASTENERS - TOOLS - STRUCTURE
FOR DECKING

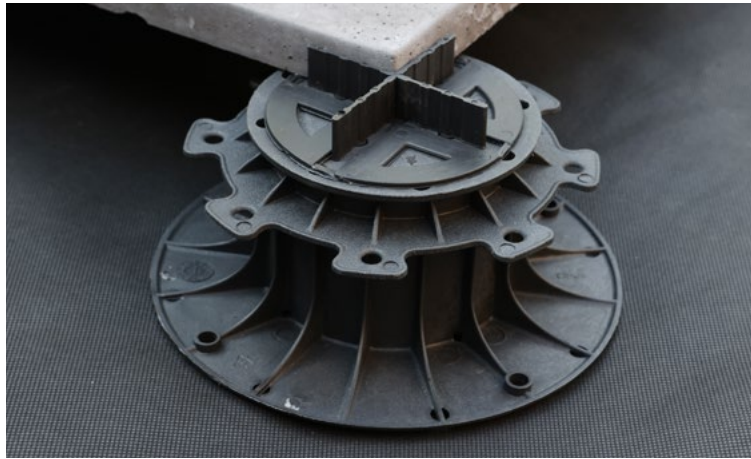



FASTENING AND STRUCTURAL SYSTEMS FOR WOOD & COMPOSITE DECKS

A successful decking project requires that you follow a few simple rules of installation and more particularly that you take into account good ventilation of the structure and avoid water traps. Wood is a living material that shrinks and expands depending on the humidity of the ambient air. It is therefore important to follow local recommendations.

Simplicity and reliability

Specialists in wood decking for more than 15 years, we have been actively involved in the development of accessories to create quality decks.

Our teams have developed many products that facilitate the installation of wooden decks such as Cobra® stainless steel clips, screwing templates or board straighteners. Other products increase the lifetime of under-structure such as pads, joist protection tape or ground screws.

Our Cobra® Hybrid clips (bi-material stainless steel clip) allows the installation of all types of boards with a 30% time saving on installation without pre-drilling. The pre-loaded screw on the clip is compatible with all joists (softwood, exotic or aluminum).

For a terrace that lasts long

Our goal is to make the construction of wood decks more reliable by proposing innovative concepts such as the "Structural" aluminum structure. A rot-proof and solid structure that increases the life of the decks, but also improves their stability.

Cobra® fastener

"Smart" products to succeed in your projects in complete safety. Reliable and proven products, flexible logistics and an always available stock to be your partner for decking accessories.

FASTENERS

- Cobra® HYBRID clips pages 04 -07
- Cobra® finishing clips page 08
- Ventilation Pad AIRSPACER page 09
- Cobra® Universal Clips D-LOCK page 10
- Cobra® screws for wood decks / wood joists page 11
- Cobra screws for Composite wood deck / wood joists page 12
- Cobra® screws for wood decks / Aluminum joists page 13

TOOLS

- Cobra® SMART BIT drill and countersink tool and step drill tool pages 14 - 15
- Cobra® DECKSPACER page 16
- Cobra® LINER installation template page 17
- Cobra® WRENCH board straightener page 18

STRUCTURE

- NIVO PLUS Pedestals page 19
- STRUCTURAL pages 20 - 21
- STRUCTURAL CERAM page 22
- Aluminium Joists page 23
- Ground screws, screwing tool and adapter pages 24 - 26
- Joist tapes page 27
- Antiweed felts page 28
- Decking PADS pages 29 - 30
- Cobra® SEAL page 31



Cobra HYBRID clips



UNIVERSAL - REMOVABLE – RESISTANT

- Range of clips suitable for most grooved deck boards
- Allows the use of reversible deck boards
- Integrated screw, easy handling, quick installation
- Removable clip
- Bi-material clip: nylon shell and AISI304 stainless steel reinforcement
- Resistant to UV and extreme temperatures
- Screw compatible with wood and aluminum joists
- Patented models.

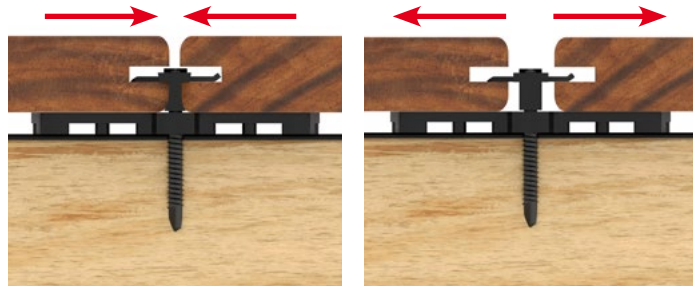
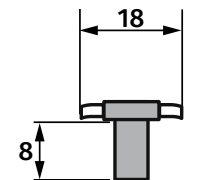
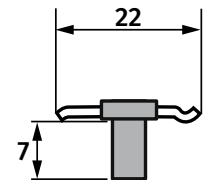
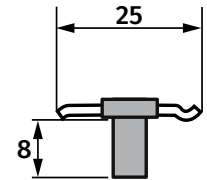
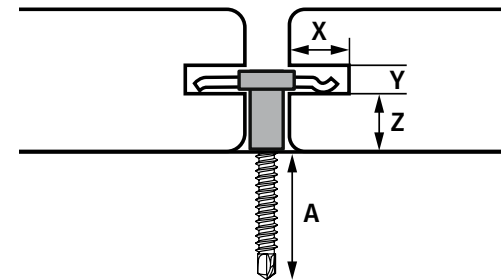
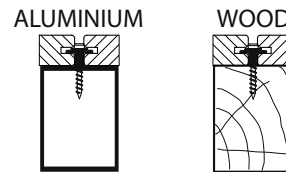
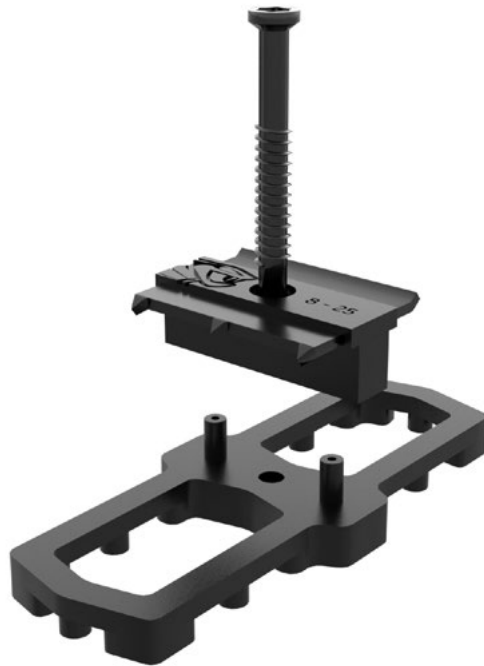

	Decking	X min	Y min	Z	A
Hybrid 8-25 	Hardwood	10 mm	4 mm	Min 8 mm	33 mm
				Max 11 mm	30 mm
Hybrid 7-22 	Thermo-treated wood	9 mm	4 mm	Min 7 mm	26 mm
				Max 10 mm	23 mm
Hybrid 8-18 	WPC or Thermo-treated wood	6 mm	4 mm	Min 8 mm	25 mm
				Max 11 mm	30 mm

FASTENERS

Cobra HYBRID 8-25 clips



Features

- Very strong screw: diameter 4.8 mm
- 43 mm screw length: excellent grip in the wood joist
- Nylon honeycomb body: absorbs the swelling of the boards by deforming
- Asymmetrical stainless steel wing: 1 side grips and holds the blade/ 1 curved side plates the board and allows the wood to expand
- Box of 90 clips: corresponds to 4-5 m² of terrace surface.



Code FR	Code NL	EAN Code	Qty/package	Qty/pallet	Weight (kg)
0964	2662	3700421809646	8	512	1,05

Dimensions (mm)

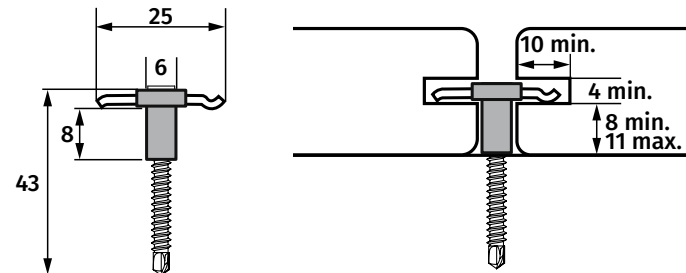

Decking

Exotic woods	Thermo-modified wood	Composite wood
✓	✓	-

Structure

Exotic woods*	Softwood	Aluminium**	Steel
✓	-	✓	-

* Stable and dried species KD

Cobra HYBRID 7-22 clips



Features

- Screw: diameter 4.2 mm
- 35 mm screw length: self-drilling wood/aluminum head
- Nylon honeycomb body: absorbs the swelling of the blades by deforming
- Asymmetrical stainless steel wing: 1 side grips and holds the blade/ 1 curved side plates the board and allows the wood to expand
- Box of 90 clips: corresponds to 4-5 m² of terrace surface.



Code FR	Code NL	EAN Code	Qty/package	Qty/pallet	Weight (kg)
1334	2661	3700421813346	8	640	0,88

Dimensions (mm)

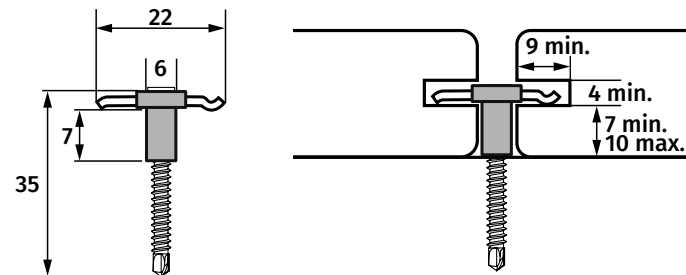

Decking

Exotic woods*	Thermo-modified wood	Composite wood
-	✓	-

Structure

Exotic woods*	Softwood	Aluminium**	Steel
✓	✓	✓	-

* Stable and dried species KD

FASTENERS

Cobra HYBRID 8-18 clips



Features

- Screw: diameter 4.2 mm
- 35 mm screw length: self-drilling wood/aluminium head
- Stainless steel claw blade: penetrates the material and locks the blade longitudinally
- Box of 90 clips: corresponds to 4-5 m² of terrace surface.



Code FR	Code NL	EAN Code	Qty/package	Qty/pallet	Weight (kg)
0993	2174	3700421809936	20	600	1,00

Dimensions (mm)

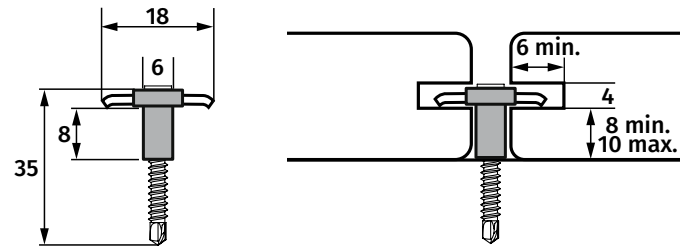

Decking

Exotic woods*	Thermo-modified wood	Composite wood
-	✓	✓

Structure

Exotic woods*	Softwood	Aluminium**	Steel
✓	✓	✓	-

* Stable and dried species KD

Cobra finishing clips



Features

- Aesthetic finish of a deck installed with Cobra clips
- Stainless steel clip AISI304 (30 pcs)
- Screw 4.5x25 mm in stainless steel AISI304 (30 pcs)
- Resistant to UV and extreme temperatures
- Color matte black for no light reflection



Designation	Code FR	Code NL	Code EAN	Qty/package	Qty/pallet	Weight (kg)
Cobra 20 Start/End	0336	1773	3700421803361	16	960	0,60
Cobra 24 Start/End	0335	1774	3700421803354	16	960	0,65
Cobra End	1432	2704	3700421814329	16	960	0,60

Dimensions (mm)

Designation	X	Y	Z
Cobra 20 Start/End	8	4 mm	10 mm
Cobra 24 Start/End	10	4 mm	10 mm
Cobra End	-	4 mm	8 mm

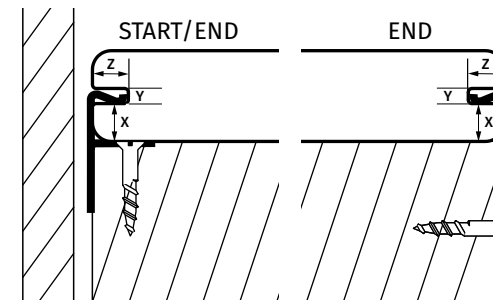

Decking

Exotic woods	Thermo-modified wood	Composite wood
✓	✓	✓

Structure

Exotic woods*	Softwood	Aluminium	Steel
✓	✓	-	-

*Pre-drilling required

AIRSPACER ventilation pad



Features

- 4 board spacers 3 / 4 / 5 / 6 mm included.
- Provides ventilation between the boards and joists.
- Increases the lifetime of the deck.
- Recycled polyamide, UV, heat and frost resistant.
- Complies with the decking standards requirements
- Compatible with Hybrid clips 7-22 and 8-25.

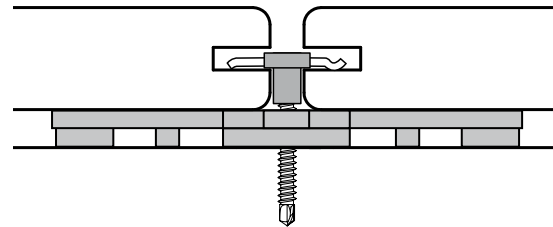

Dimensions (mm)

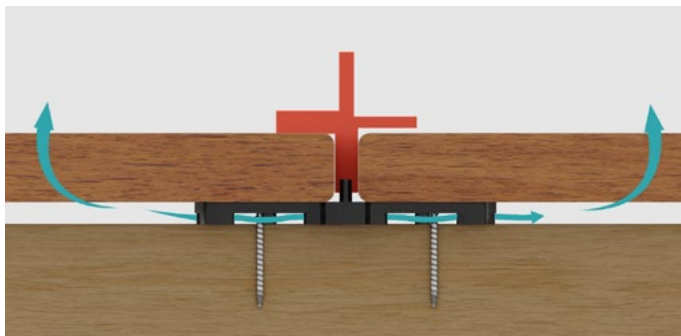

Code FR	Code NL	EAN Code	Qty/package	Qty/pallet	Weight (kg)
1040	-	3700421810406	8	192	0,75

Contents

- 100 AIRSPACER®
- 4 boards spacers: DECKSPACER®

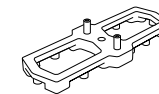

x 100

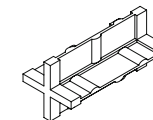

x 4

D-LOCK universal clips



Intermediate clip

Start/End Clip

Features

- Universal clip for deck boards from 20 to 28 mm thick and 90 to 150 mm wide.
- Fastening system adapted to non grooved decking boards
- Provides ventilation under the board
- Strong and resistant to humidity and extreme temperatures
- Made of polymer material of the POM type: polyoxymethylene
- Compatible with all wood decking and structure, with compulsory pre-drilling.

Code FR	Code NL	EAN Code	Qty/package	Qty/pallet	Weight (kg)
0600	-	3700421806003	8	144	2,20



Dimensions (mm)

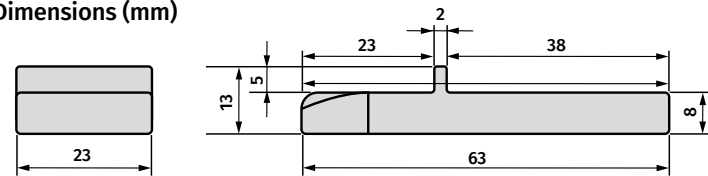

Contents

- 110 Fixing clips dimension: 23x60x8mm
- 15 Start/End Clips
- 250 stainless steel screws: 4x25 mm
- 55 stainless steel screws: 4x40 mm
- 1 Metal drilling template
- 4 board spacers: DECKSPACER®.

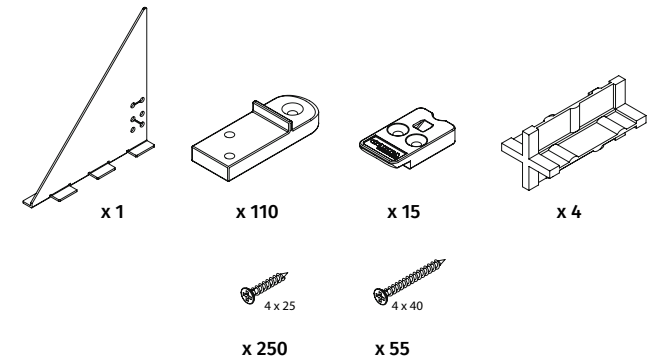

FASTENERS

Cobra screws wood decking



Features

- Stainless steel screws AISI304
- Sharp thread for better penetration in wood
- Sharp point to reduce wood splitting
- Spiral top to facilitate the penetration of the screw in the wood
- Deep Torx recess to prevent bit rejection and slippage

Designation	Code FR	Code NL	EAN Code	Qty/package	Qty/pallet	Weight (kg)
5x50 mm (200 pcs)	0601	2392	3760180240470	12	288	0,90
5x50 mm (500 pcs) + 4 spacers + 1 drill bit	0799	-	3760180247448	6	144	2,25
5x60 mm (200 pcs)	0602	2393	3760180240852	6	288	0,98
6x70 mm (100 pcs)	0613	2394	3700421806133	6	288	0,95

Dimensions (mm)

Designation	Size	A (mm)	L (mm)	U (mm)	D (mm)	dr (mm)	Torx
0601 - 0799	M5x50	8	50	4	5	4	T25
0602	M5x60	8	60	8	5	4	T25
0613	M6x70	10	70	10	6	5	T30

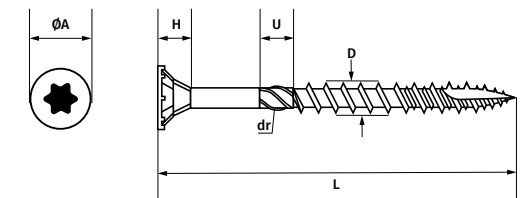

Decking*

Designation	Board thickness (mm)**	Density of the wood (kg/m³)	
		<600	>=600
0601 - 0799	21-23	Screw M5x50	Screw M5x60
0602	24-27	Screw M5x60	Screw M6x70
0613	28	Screw M6x70	Screw M6x70

Structure

Exotic woods**	Softwood	Aluminium	Steel
✓	✓	-	-

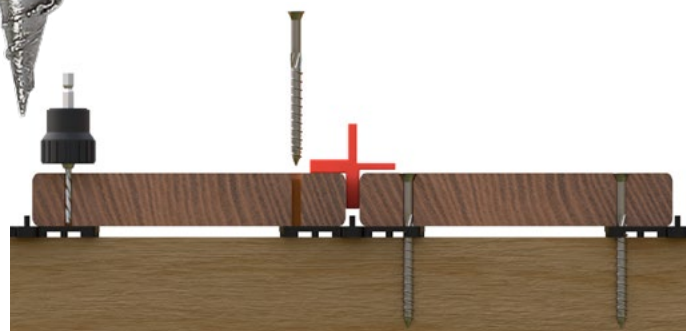

* According to decking standards requirements
** Pre-drilling is strongly recommended in hardwoods

FASTENERS

Cobra screws composite decking



Features

- Stainless steel screws AISI304
- Sharp thread for better penetration in composite wood
- Reduced head
- Double thread to avoid mushrooming effect
- Identical colors to the boards for a nice finish
- Compatible with all brands of solid core composite wood



Designation	Code FR	Code NL	EAN Code	Qty/package	Qty/pallet	Weight (kg)
5x50 mm Grey (150 pcs)	0770	2026	3700421807703	30	900	0,85
5x50 mm Brown (150 pcs)	0771	2027	3700421807710	30	900	0,85
5x63 mm Grey (100 pcs)	0729	-	3700421807291	30	900	0,55
5x63 mm Brown (100 pcs)	0728	-	3700421807284	30	900	0,55

Dimensions (mm)

Designation	Size	A (mm)	L (mm)	D1 (mm)	D2 (mm)	D3 (mm)	Torx
0770 - 0771	M5 x 50	7,5 - 8	50	5,2-4,9	4,0-4,3	4,9-5,2	T20
0728 - 0729	M5 x 63		63				

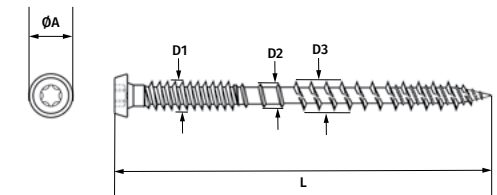

Decking

Designation	Boardthickness (mm)	Screw size
0770 - 0771	20-22	M5 x 50
0728 - 0729	24	M5 x 63

Structure

Exotic woods*	Softwood	Aluminium	Steel
✓	✓	-	-

* Pre-drilling required

FASTENERS

Cobra screws wood decking



Features

- AISI316 stainless steel screws: Compatible with areas highly exposed to saline environments.
- Narrow, stepped screw head to reduce wood splintering.
- Small Head perfectly embedded, optimal pressing
- Wing for self-drilling of the wood board, and brittle in aluminum
- Self-drilling point. Aluminium wall drilling up to 3 mm.



Designation	Code FR	Code NL	EAN Code	Qty/package	Qty/pallet	Weight (kg)
5.5x40 mm (200 pcs)	0955	2395	3700421809554	12	360	1,10
5.5x50 mm (200 pcs)	1258	2615	3700421812585	8	240	1,35

Dimensions (mm)

Designation	Size	A (mm)	L (mm)	D (mm)	lt (mm)	Torx
0955	M5.5 x 40	7,9 - 8	40	5,5	9,5	T20
1258	M5.5 x 50		50			

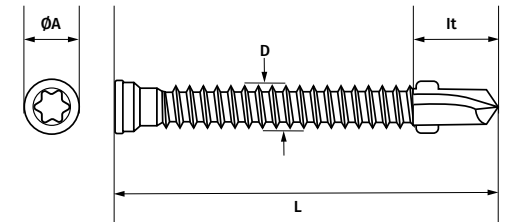

Decking

Designation	Board thickness (mm)	Screw size
0955	20-22	M5.5 x 40
1258	22-28	M5.5 x 50

Structure

Exotic woods*	Softwood	Aluminium	Steel
-	-	✓	-



TOOLS

Cobra SMART BIT drill and countersink



Features

- 2 in 1 tool: drill and countersink the deck board for a perfect finish.
- Stop on anti-track bearing thanks to a rubber damping ring.
- 3 HSS Powerbolic® steel drill bits, interchangeable
- Chip Cavity
- Compatible with Cobra screws for wood and WPC



Designation	Code FR	Code NL	EAN Code	Qty/package	Weight (kg)
Cobra Smart-bit #8 - 4.5	0214	1770	3700421802142	96	0,10
Cobra Smart-bit #10 - 5.0	0215	1771	3700421802159	96	0,10
Cobra Smart-bit #12 - 6.0	0218	1772	3700421802180	72	0,13

Dimensions (mm)

Designation	φA (mm)	φB (mm)	C (mm)	α (°)
#8 - 4.5	3,2	6,6	30	60
#10 - 5.0	3,6	9,2	30	90
#12 - 6.0	4,0	11	40	82

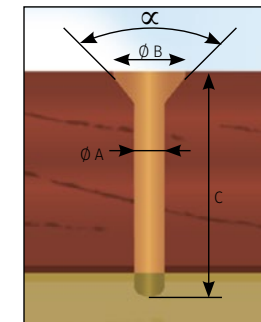
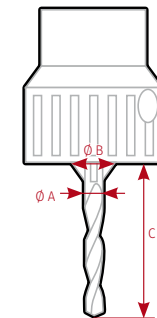

Decking

Exotic woods	Thermo-modified wood	Composite wood
✓	✓	✓

Structure

Exotic woods	Softwood	Aluminium	Steel
✓	✓	-	-



- 1 - Pre-drilling countersink tool
- 2 - Replacement drill bit
- 3 - Hexagonal wrench

Damping ring

TOOLS

Cobra step drill



Features

- Wood drill + Chamfering cutter with 5 blades
- Height-adjustable drill bit with allen key
- Compatible with Cobra screws M5x50 mm and M5x60 mm

Code FR	Code NL	EAN Code	Qty/package	Weight (kg)
0801	2396	3700421806843	20	0,04



Dimensions (mm)

ØA (mm)	ØB (mm)	C (mm)	α (°)
4,0	11	25-40	90 ± 5

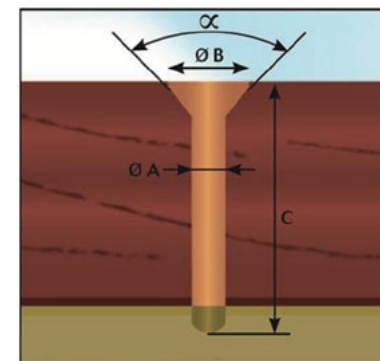

Decking

Exotic woods	Thermo-modified wood	Composite wood
✓	✓	✓

Structure

Exotic woods	Softwood	Aluminium	Steel
✓	✓	-	-

Cobra DECKSPACER

Features

- Ensures regular spacing between boards for expansion and shrinkage of wood, in accordance with the decking standards requirements.
- Guarantees a linear expansion gap at the end of the composite wood boards.
- 4 fins with 4 different spacings

Code FR	Code NL	EAN Code	Qty/package	Qty/pallet	Weight (kg)
0604	2338	3700421806041	20	480	0,08



Dimensions (mm)

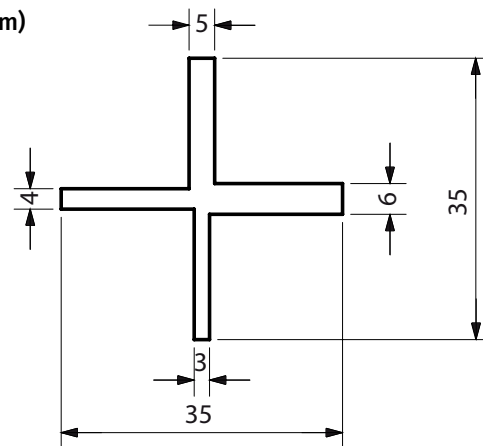

Decking

Exotic woods	Thermo-modified wood	Composite wood
✓	✓	✓

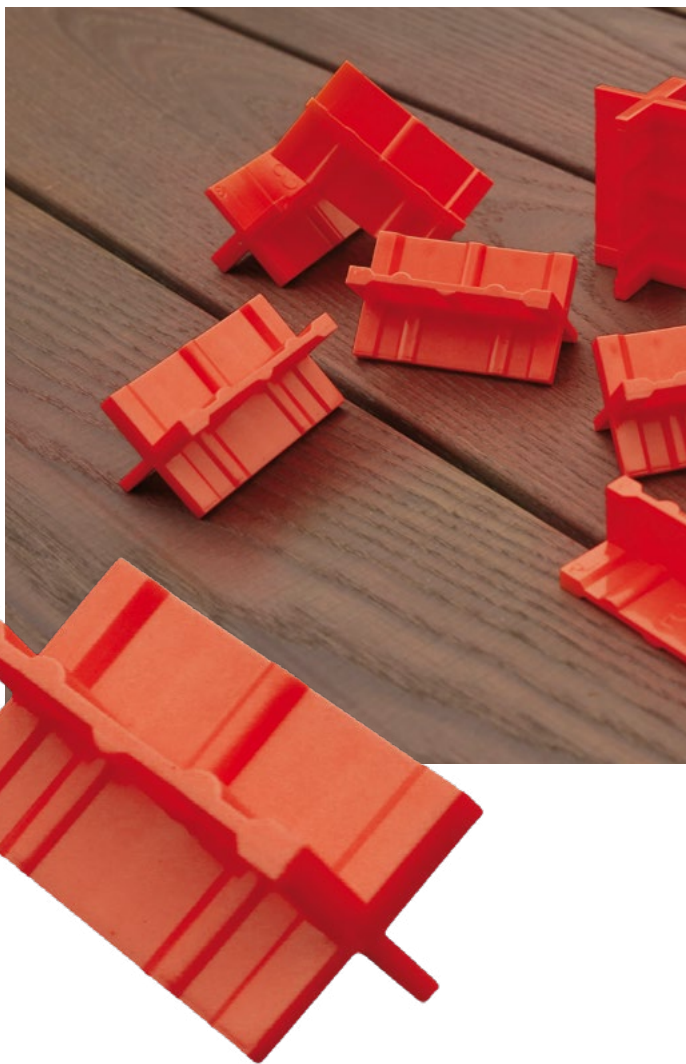

TOOLS

Cobra LINER drilling template

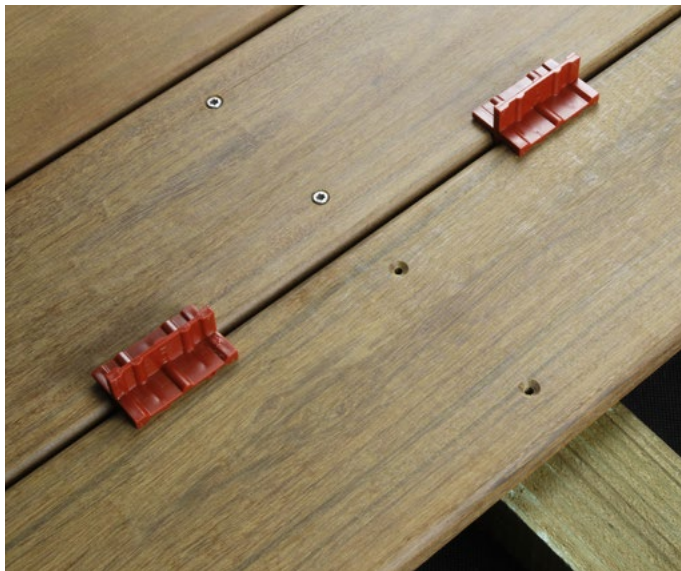

Features

- Ensures perfect alignment of the screws when screwing in the deck board
- Guarantees 20 mm screw distance from the edge of the boards, in accordance with decking standards
- Adjustable with all boards widths
- Time saving, easy to use
- Supplied with 4 DECK SPACERS included

Code FR	Code NL	EAN Code	Qty/package	Qty/pallet	Weight (kg)
0603	2397	3760178992091	20	480	0,63

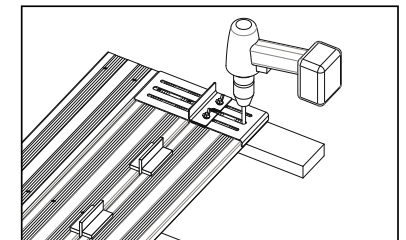
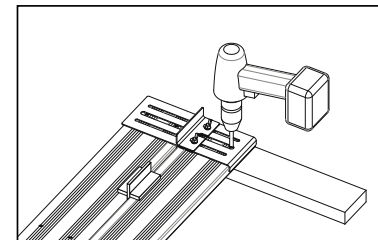
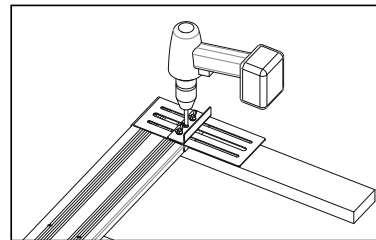

TOOLS

Cobra WRENCH board straightener



Features

- Allows to straighten deformed deck boards with edge deflection
- Easy to use, for a right or left handed user
- Ergonomic and lightweight tool
- Supplied with pins of different sizes, adjustable to the dimensions of the joists



Code FR	Code NL	EAN Code	Qty/package	Qty/pallet	Weight (kg)
0216	1056	3760178990349	2	80	1,50

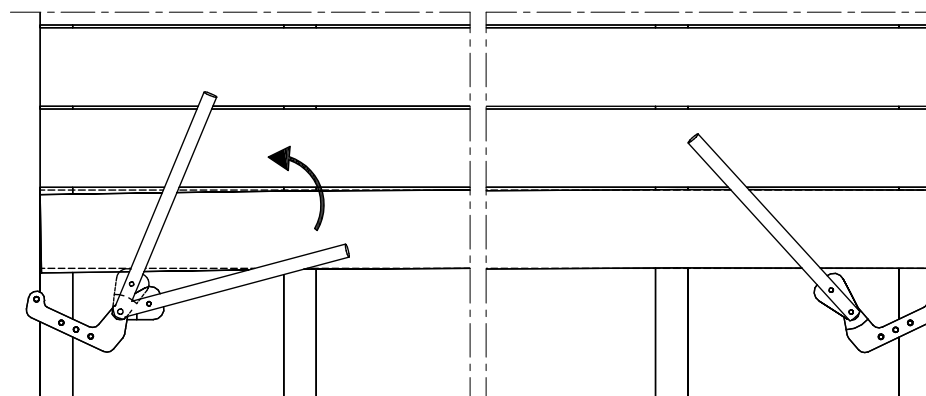



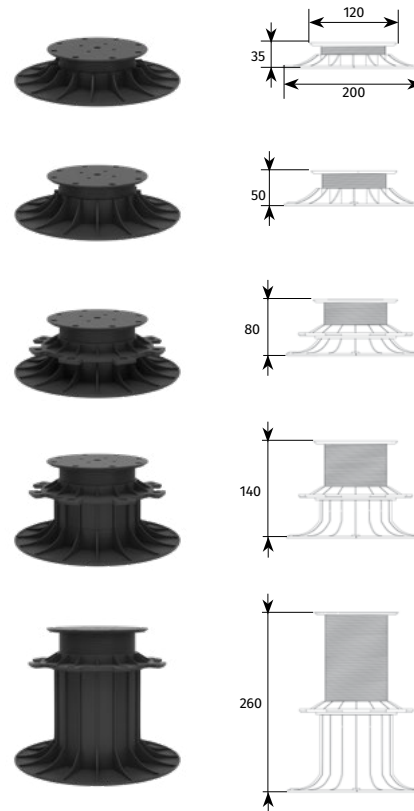

UNIVERSAL PEDESTALS FOR TILES AND JOISTS



Features

- Adjustable pedestals from 26 mm to 80 cm for fast and efficient installation
- Precise height adjustment with adjustment ring
- Sturdy, support up to 1.2 tons in the raised position. Ideal for commercial and public use terraces
- Maintains its strength and stability even under heavy and frequent use
- Allows air to circulate under the deck, as well as the passage of cables and pipes
- Compatible with tiles, joists and the STRUCTURAL® concept

Designation	Code FR	Code NL	EAN Code	Qty/package	Qty/pallet	Weight (kg)
H 26 - 35 mm	1349	2671	3700421813490	90	2250	0,18
H 35 - 50 mm	1350	2672	3700421813506	66	1650	0,20
H 50 - 80 mm	1351	2673	3700421813513	48	1200	0,26
H 80 - 140 mm	1352	2674	3700421813520	30	750	0,34
H 140 - 260 mm	1353	2675	3700421813537	18	450	0,50

	Designation	Code FR	Code NL	EAN Code	Qty/package	Qty/pallet	Weight (kg)
	Head for tiles	1354	2676	3700421813544	750	-	0,012
	Head for joist	1355	2677	3700421813551	250	-	0,02
	Damping wedge for tiles	1356	2678	3700421813568	400	-	0,02



Designation	Code FR	Code NL	EAN Code	Qty/package	Qty/pallet	Weight (kg)
Structural joist adapter	1357	2679	3700421813575	200	-	0,02
Slope corrector	1359	2680	3700421813599	30	-	0,075
Extension stud 60 mm	1360	2681	3700421813605	126	3150	0,085

STRUCTURE

STRUCTUR'AL concept



Features

- Strong, rot-proof, ultra-light and quick to install thanks to the Cobra® Tee-Al clip
- Superior durability to conventional wood structures in all weather conditions
- Extends the life of the structure and the guarantee of the decking
- Excellent mechanical resistance, no deformation, perfect flatness

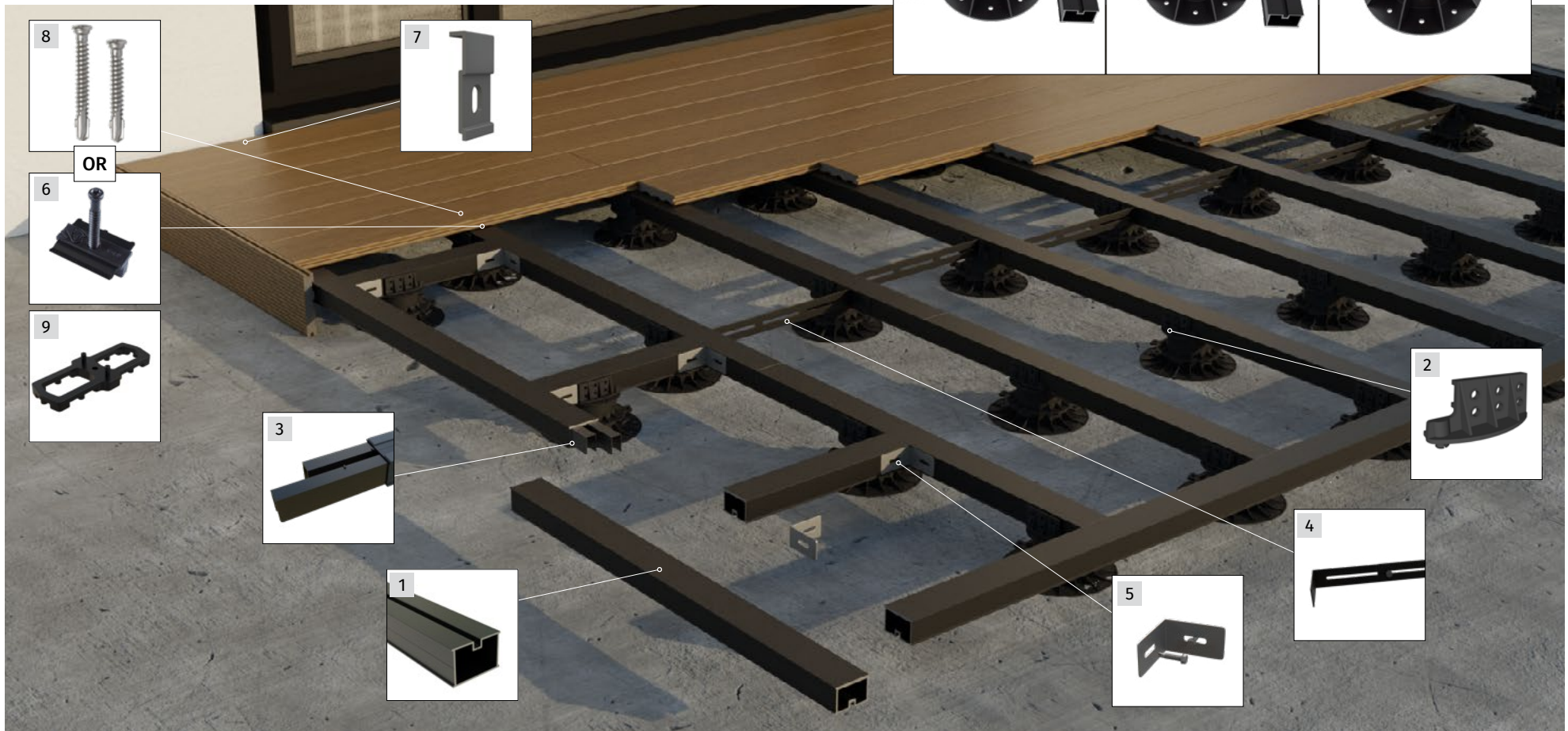

STRUCTURE

STRUCTUR'AL concept

N°	Designation	Code FR	Code NL	EAN Code	Qty/package	Qty/pallet	Weight (kg)
1	Aluminum joists 40x60x3000 mm	0676	-	3700421806768	-	180	4,28
1.1	Aluminum joists 40x60x4000 mm	1386	2192	8720039024700	-	96	5,70
2	Adapter NIVO PLUS - joist 40x60 mm	1357	2568	3760178994620	270	-	0,02
3	Sleeve connector (10 pcs)	0687	2187	3700421806874	20	400	0,40
4	Joist bridge 30 to 50 mm (4 pcs)	0965	2616	3700421809653	20	480	0,50
5	Black bracket 35x35x1,5 mm (20 pcs)	0686	2193	3700421806867	20	400	0,26
6	Cobra HYBRID 8-25	0964	2662	3700421809646	8	512	1,05
6.1	Cobra HYBRID 7-22	1334	2661	3700421813346	8	640	0,88
6.2	Cobra HYBRID 8-18	0993	2174	3700421809936	20	600	1,00
7	Start/end clip (10 pcs)	0689	2196	3700421806898	20	400	0,23
8	5.5x40 mm (200 pcs)	0955	2395	3700421809554	12	360	1,10
	5.5x50 mm (200 pcs)	1258	2615	3700421812585	8	240	1,35
9	Ventilation Pad AIRSPACER	1040	2619	3700421810406	9	192	0,75

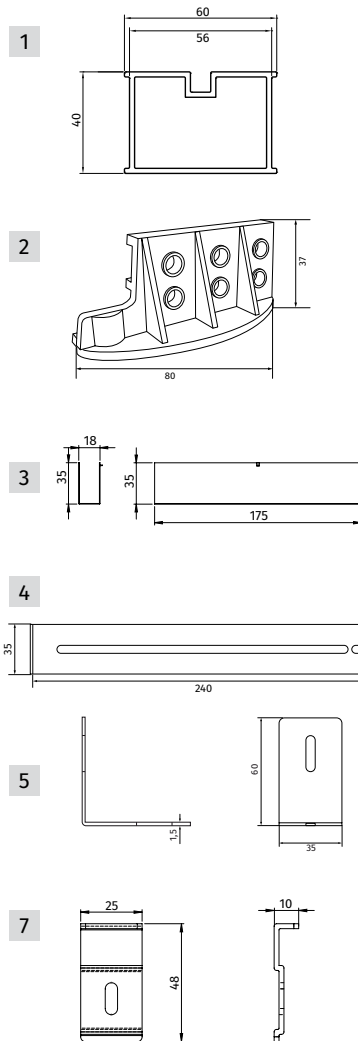

Fixing with Cobra inox screws



Fixing with universal Cobra Hybrid clip

	Residential application	Commercial application
Distance between 2 supports maximum	75 cm	37,5 cm

STRUCTURE

STRUCTUR'AL CERAM concept



Features

- Compatible with all sizes of ceramic tiles
- Extremely stable
- Clip-on finishing skirting

N°	Designation	Code FR	Code NL	EAN Code	Qty/package	Qty/pallet	Weight (kg)
1	EPDM Tape 5x10 mm - 20 m	0939	2389	3700421809394	20	200	0,16
2	Braces (100 pcs)	0866	2416	3700421808663	10	-	0,20
3	Top/Bottom bracketss - 4 sets	0864	2418	3700421808649	10	-	0,18



STRUCTURE

Aluminium Joists & Accessories

N°	Designation	Code FR	Code NL	EAN Code	Qty/package	Qty/pallet	Weight (kg)
1	Joists 30x50x4000 mm	1332	2179	3700421813322	-	150	1,98
2	Sleeve connector (4 pcs)	1024	2391	3700421810246	10	400	1,50
3	Square (20 pcs) + Screws (40 pcs)	1032	2390	3700421810321	20	400	0,26

Designation	Code FR	Code NL	EAN Code	Qty/package	Qty/pallet	Weight (kg)
Alu joist 24x40 mm x 4,0 m - Thickness 2 mm	-	1725	8718104305540	-	240	3,50
EPDM tape 5x10 mm - 20 m	0939	2389	3700421809394	20	200	0,16

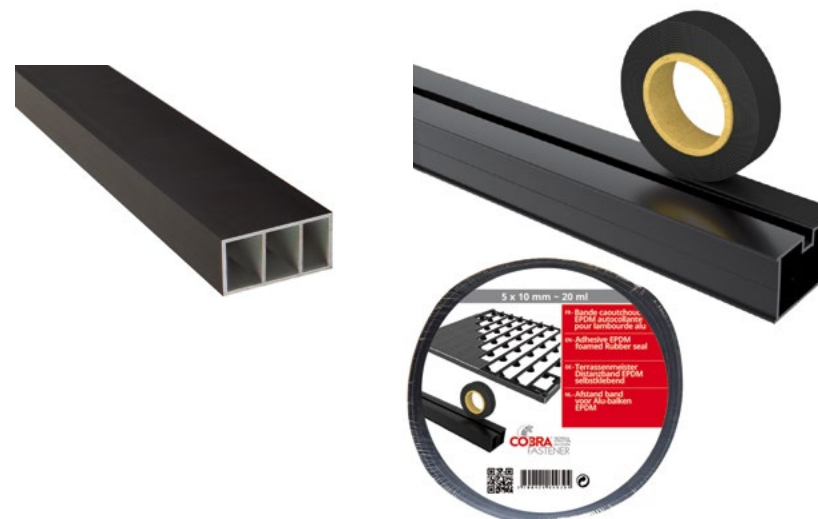
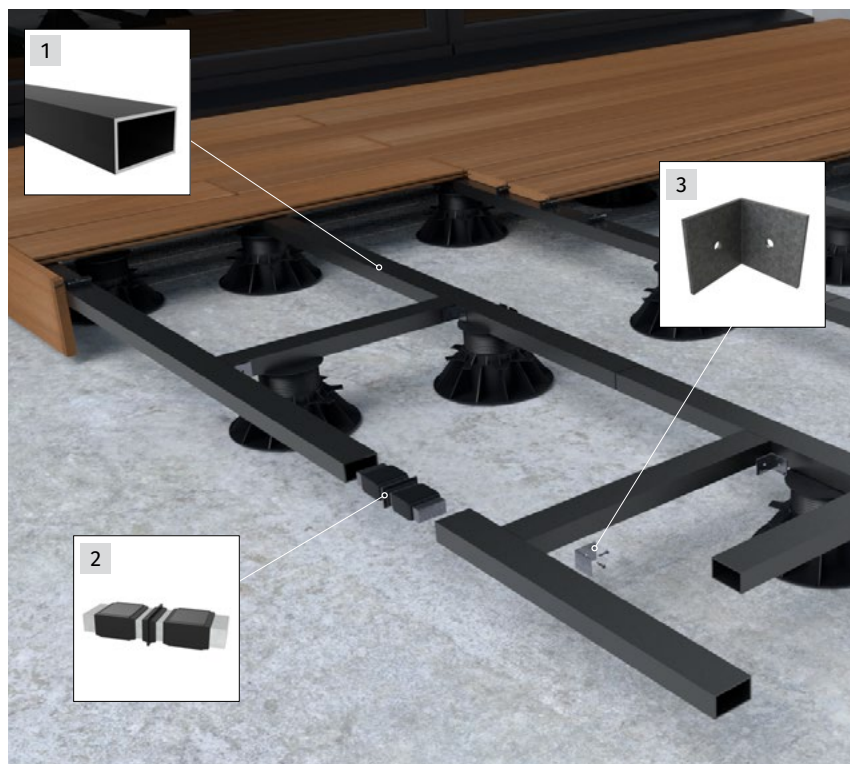



Features

- Hot galvanized steel according to NF EN ISO 1461:2009 standard
- Easy to install: No holes to dig, no concrete to pour, no soil to evacuate
- Low cost : Less expensive than a concrete structure
- Strong : up to 450 kg of load compression
- Removable L-shaped support included, compatible with most joists in the market
- Flat bracket (sold separately) for fixing vertical posts
- Easy to remove and reusable

Designation	Code FR	Code NL	EAN Code	Qty/package	Qty/pallet	Weight (kg)
800 x Ø 60 cm	0614	2383	3700421806140	1	56	5,00
1200 x Ø 60 cm	1220	2617	3700421812202	1	56	7,50
Flat support 90x90 mm	1221	2618	3700421812219	20	300	0,70

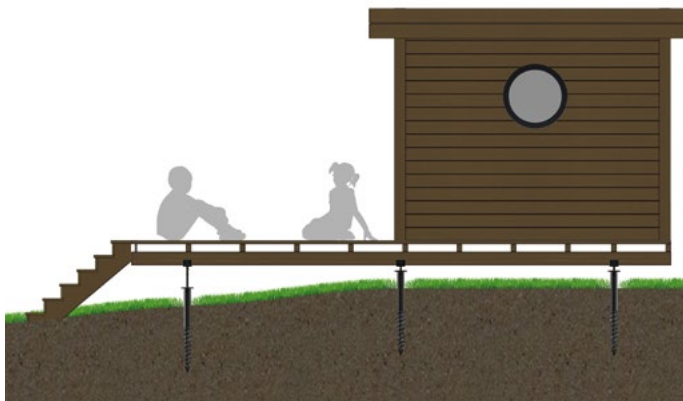
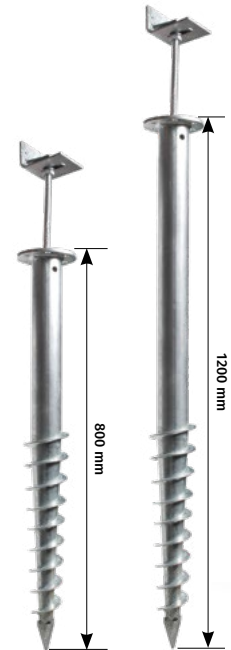
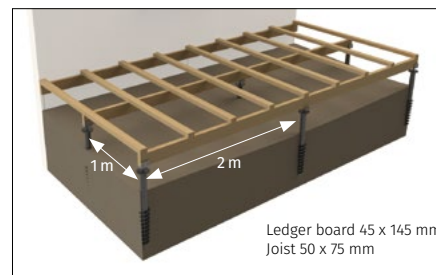
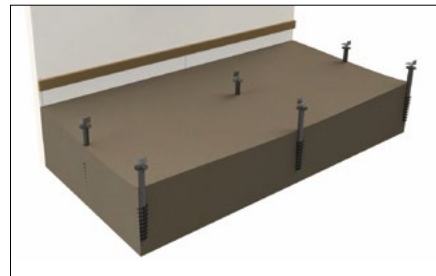

STRUCTURE

Ground screws

MANUAL SCREWING

Features

- Allows the ground screw to be anchored manually without the use of other materials
- Manual screwing bar with height adjustment as you screw in.
- Wingspan of 160 cm: an important lever arm for easy tightening

Code FR	Code NL	EAN Code	Qty/package	Qty/pallet	Weight (kg)
0615	2384	3700421806157	1	49	7,90

Manual tool kit



Manual or electric screwing time: < 5 minutes.



MECHANICAL SCREWING

Features

- Adapter for mechanical screwdriving with impact bolting machine
- Compatible with the Makita TW1000 Impact Bolting Machine, BOSCH Gds 30 Professional, Hitachi Wr25SE 900W 1000 Nm

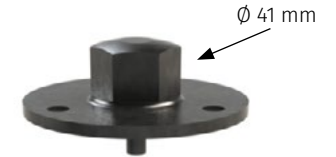

Code FR	Code NL	EAN Code	Qty/package	Qty/pallet	Weight (kg)
0616	2385	3700421806164	10	200	1,35



STRUCTURE

Electrical screwing machine



Features

- Low noise level
- No shaking
- Adjustable speed and torque
- Telescopic arm keeps the screwdriver in line
- Reliable and robust
- Installation of 10 screws per hour
- Wooden box size: LxDxH = 58 x 23 x 66 cm

Designation	Code FR	Code NL	EAN Code	Qty/package	Qty/pallet	Weight (kg)
Electrical screwing machine Cobra® XS 2.5	1041	-	3700421810413	1	-	17,60
Aluminum telescopic mast	1435	-	3700421814350	1	-	9,00

Features

Property	Cobra® XS 2.5
Maximum torque	2.500Nm
Square head size	1"
Cobra ground screw adapter	included
Power	1800 W
Safety stop	Yes
adjustable speed	Yes
Forward / Backward	Yes
Power supply	230 Volts
Warranty	1 year
Made in	Germany
CE compliance	EN 60 745 according to 2011/65/EU, 2004/108/EG, 2006/42/EG

Features

- Length: 150 / 275 cm
- Outside diameter: 80 mm
- Inner diameter: 70 mm
- Material: aluminum (thickness 5 mm)



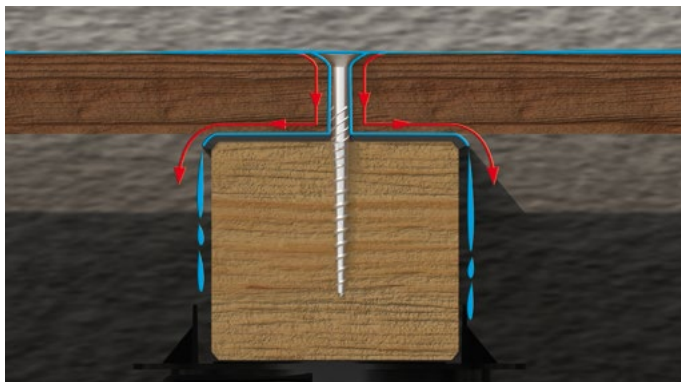

water circulation

Features

- Increases the life time of wooden joists
- Complies with the requirements of decking standards
- Waterproof - Absorbs sound resonance
- Matte black color to avoid light reflections between boards
- Resists tearing, deformation, and temperature variations
- Easy and convenient to use

Designation	Code FR	Code NL	EAN Code	Qty/package	Qty/pallet	Weight (kg)
BITUDECK	0145	2306	3760178990196	8	240	1,55
PROTAPE	1329	-	3760178994644	24	432	0,31

Dimensions & Properties

Property	Bitudeck	Protape
Nominal thickness	1.5 mm	1 mm
Width	75 mm	80 mm
Length	10 m	20 m
Upper side	Self-adhesive elastomeric bitumen	Reinforced PER foam
Bottom side	Film HDPE	acrylic
Tensile strength	150 N	720 kPa
Resistance to nail tearing	25 N	-
Operating temperature	-20°C to +70°C	De -40°C to +90°C
Storage conditions	+15°C	> 0°C
Waterproofing	0.3 mpa, 120 min	-
Stickiness	1.5	35 N/25 mm





ANTI-WEED FELT 100 GR/M²

Features

- Prevents weed regrowth
- Can be laid directly on the ground, soil, grass...
- Water permeable

Code FR	Code NL	EAN Code	Dimensions	Qty/package	Qty/pallet	Weight (kg)
0607	2387	3760178990219	2x10=20 m ²	15	60	2,00

Properties

Weight	Thickness	Resistance to tearing*	Widthwise traction**	Elongation at maximum tensile load
100 g/m ²	0.55 mm	0.413 kN	13.6 kN/m	132%

*ISO 12236 : 2006
**ISO 10319 : 2015

MULCHING FABRIC 100 GR/M²

Features

- Prevents weed regrowth
- Can be laid directly on the ground, soil, grass...
- Water permeable

Code FR	Code NL	EAN Code	Dimensions	Qty/package	Qty/pallet	Weight (kg)
-	1032	8718104300576	2x5=10 m ²	10	150	1,00



FLATPAD

Features

- Quick and accurate upgrade
- Allows to correct thicknesses from 2 to 5 mm
- Rot-proof, strong and UV-resistant

Code FR	Code NL	EAN Code	Qty/package	Qty/pallet	Weight (kg)
0135	1779	3760178990189	10	200	0,80

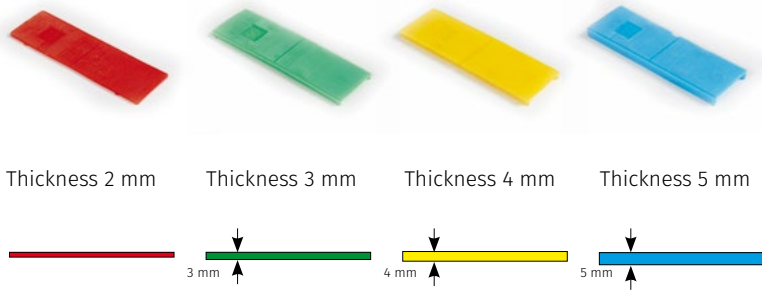

WEDGEPAD

Features

- Quick and accurate upgrade
- Allows to correct thicknesses from 10 to 30 mm
- Rot-proof, strong and UV-resistant
- Can be screwed or glued

Code FR	Code NL	EAN Code	Qty/package	Qty/pallet	Weight (kg)
0610	1780	3700421806102	6	144	1,00

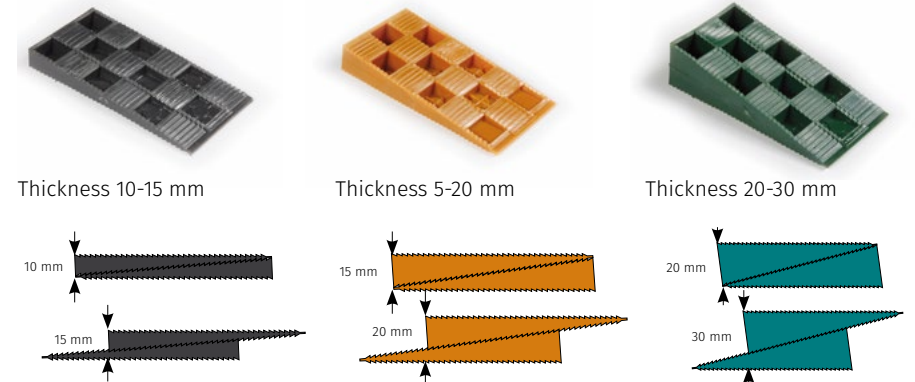

FORKPAD

Features

- Snap-on tab
- Variable opening from 8 to 12 mm
- Can be fixed into the nylon anchor

Code FR	Code NL	EAN Code	Qty/package	Qty/pallet	Weight (kg)
0679	2388	3700421806799	12	144	0,61

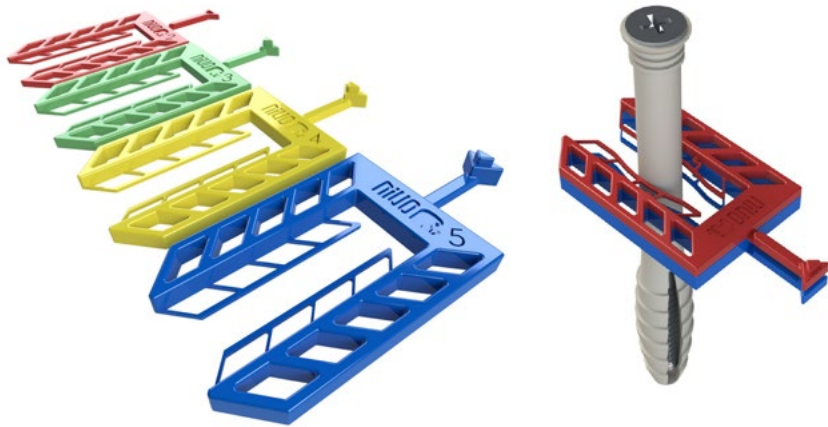

RUBBERPAD

Features

- Increases the lifetime of the under-structure
- Allows the circulation of rainwater under the joists
- Protects the joists against soil moisture
- RotproofShore hardness: 55A
- Density: 730 kg/m³



Designation	Code FR	Code NL	EAN Code	Qty/package	Qty/pallet	Weight (kg)
RubberPad 8x90x90 mm (24 pcs)	0210	1058	3760178990936	10	200	1,20
RubberPad 8x60x90 mm (48 pcs)	0608	1777	3700421806089	12	384	1,45
RubberPad 3x60x90 mm (60 pcs)	0609	1776	3700421806096	24	768	0,60

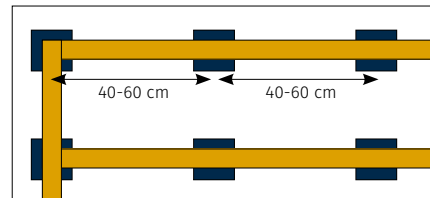

Cobra SEAL “boat deck” joint



Description

Elastomeric joint, allows a watertight seal between deck boards spaced 4 to 6 mm apart.

Composition

Thermoplastic elastomer rubber of density 1.18 TPS- type S.E.B.S. This high quality material has an excellent resistance to atmospheric agents, aging, U.V. It is 100% recyclable. Used in the automotive industry. Resists temperature variations between -50°C and +90°C.

Installation

Unroll the joint and press it by a simple thumb pressure on the elastomer cord. Thin edges hold the joint in the gap between the deck boards.

Use

Cobra SEAL is particularly suitable for covered terraces, café terraces, restaurants, bathrooms, covered swimming pool decks, covered balconies, etc. Prevents the fall of debris between the boards. Boat deck appearance. Be careful to maintain good ventilation of the terrace underneath.



Code FR	Code NL	EAN Code	Qty/package	Qty/pallet	Weight (kg)
1124	2307	3700421811243	5	60	2,90

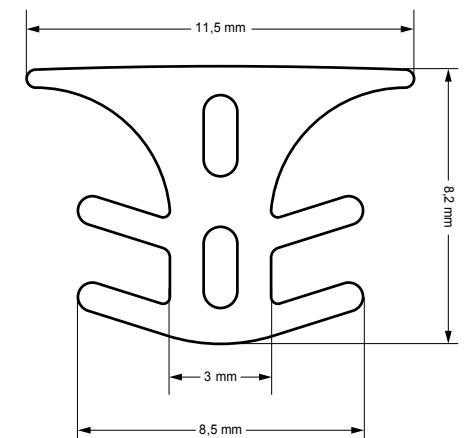
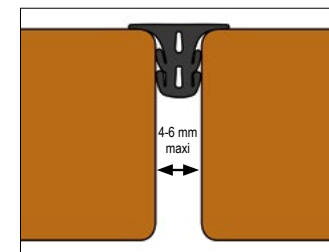
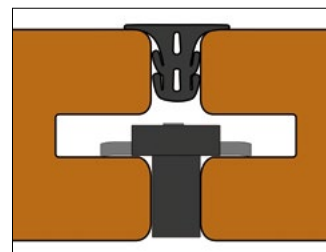



www.cobrafastener.com